

AGRAS MG-1P SERIES

MG-1P / MG-1P RTK

Quick Start Guide

V1.0

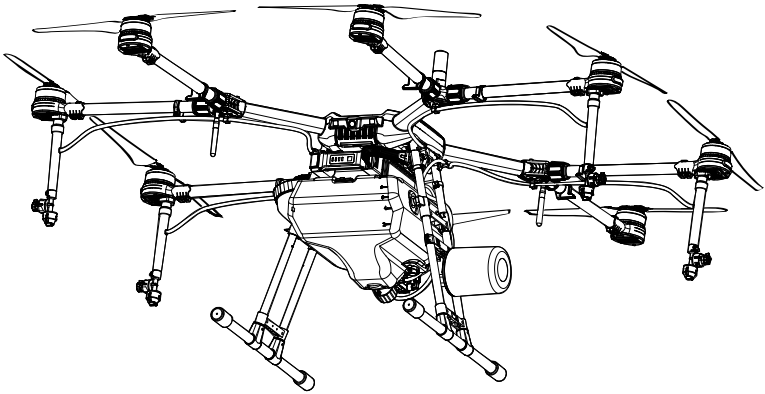

Before Flight

1. Read the *Disclaimer and Safety Guidelines* and *Quick Start Guide* carefully.



2. Download the *User Manual* and DJI ASSISTANT™ 2.
<http://www.dji.com/mg-1p/info#downloads>



3. Watch the video tutorials.
<http://www.dji.com/mg-1p/info#video>



• DJI Assistant 2 supports Windows 7 (or later) or OS X 10.11 (or later).

Aircraft

The AGRAS™ MG-1P series (MG-1P / MG-1P RTK) aircraft are equipped with a wide-angle First Person View (FPV) camera which enables observation of the landscape in front of the aircraft, allowing operation areas to be identified and enabling pilots to avoid obstacles. Its second generation high-precision radar with integrated obstacle avoidance radar module and forward, backward, and downward altitude stabilization radar modules provides improved obstacle sensing and terrain following capabilities.

The quality of the aircraft's industrial design and materials make it dust-proof, water-proof (IP43 protection rating, IEC standard 60529), and corrosion-resistant.

The MG-1P and MG-1P RTK utilize DJI's dedicated A3 flight control system with eight-rotor propulsion redundancy, ensuring safe and stable operation at all times. The MG-1P RTK has a built-in DJI™ Onboard D-RTK™, which provides more accurate data for centimeter-level positioning.

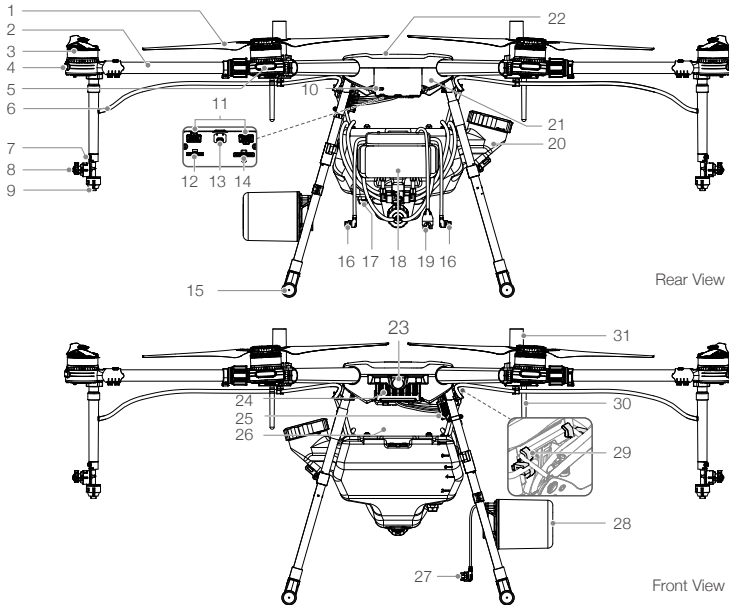

- | | | |
|---|-----------------------------|---|
| 1 Propellers | 11 Pump Ports | 22 GNSS Module |
| 2 Frame Arms | 12 Radar Port | 23 FPV Camera |
| 3 Motors | 13 Micro USB Port | 24 Intake Vent |
| 4 ESC LEDs
(on M1-M4 and M7-M8 arms) | 14 Liquid Level Meter Port | 25 Power Port |
| 5 Aircraft Status Indicators
(on M5-M6 arms) | 15 Landing Gear | 26 Battery Compartment |
| 6 Hoses | 16 Pump Cables | 27 Radar Cable |
| 7 Sprinklers | 17 Liquid Level Meter | 28 Radar Module |
| 8 Manual Relief Valve | 18 Delivery Pumps | 29 Remote Controller Holder |
| 9 Nozzles | 19 Liquid Level Meter Cable | 30 OCUSYNC™ Dual-band Antennas |
| 10 Link Button | 20 Spray Tank | 31 Onboard D-RTK™ Antennas
(on MG-1P RTK only) |
| | 21 Aircraft Body | |



- DO NOT obstruct the GNSS module (located at the center of the aircraft), as doing so would reduce the GNSS signal strength.
- The MG-1P and MG-1P RTK do not come with a battery. Please purchase the DJI approved battery pack (Model: MG-12000P).

* This should be used with a DJI Base Station (sold separately) or a DJI approved Network RTK service.

Remote Controller

The remote controller uses the DJI OcuSync dual-band video downlink system, has a maximum control distance of up to 3.11 mi (5 km)*, and is equipped with a bright, dedicated screen with the DJI MG app built-in. Operation planning can be performed either using the remote controller only or by flying the aircraft to waypoints. The Banked Turning feature in the DJI MG app commands the aircraft to take corners without fully stopping, making flight operations more flexible and efficient. The remote controller's Multi-Aircraft Control mode can be used to coordinate the operation of up to five aircraft at the same time, enabling pilots to work very efficiently. Replaceable batteries make it easy to use the remote controller every day and removable antennas make maintenance easier.

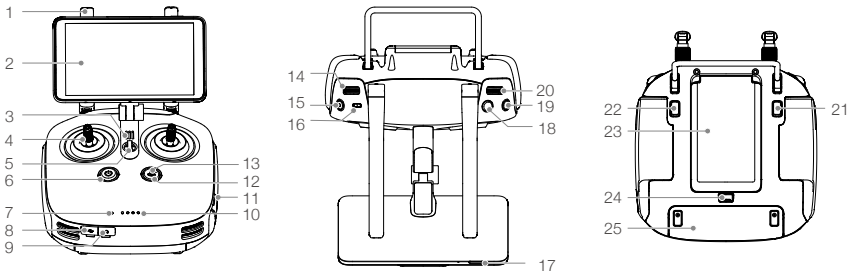

- | | | |
|----------------------|----------------------------|-----------------------------------|
| 1 Antennas | 10 Battery Level LEDs | 19 Button B (customizable) |
| 2 Display Device | 11 microSD Card Slot | 20 Aircraft Control Switch Dial |
| 3 Speaker | 12 RTH Status LED | 21 Button C1 (customizable) |
| 4 Control Sticks | 13 RTH Button | 22 Button C2 (customizable) |
| 5 Lanyard Attachment | 14 Spray Rate Dial | 23 Battery Compartment Cover |
| 6 Power Button | 15 Spray Button | 24 Battery Compartment Cover Lock |
| 7 Status LED | 16 Pause Switch | 25 Dongle Compartment Cover |
| 8 USB-C Port | 17 Sleep/Wake Button | |
| 9 3.5 mm Audio Jack | 18 Button A (customizable) | |

The figure below shows the function that each control stick movement performs, using Mode 2 as an example. In Mode 2 the left stick controls the aircraft's altitude and heading while the right stick controls its forward, backward, left, and right movements.

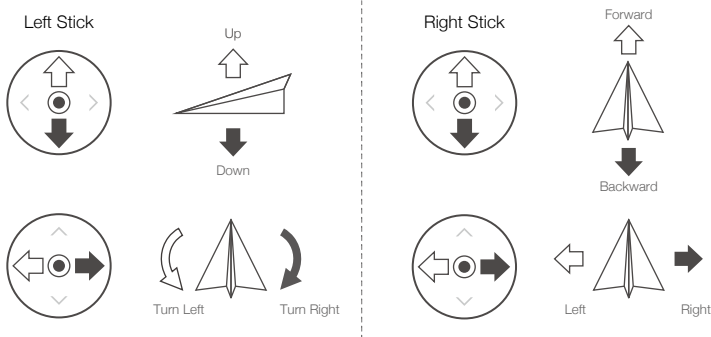

- ⚠ For more information about how to link and use the remote controller, please refer to the *Agras MG-1P / MG-1P RTK User Manual*.
- The stick mode can be selected in the DJI MG app.

* The remote controller is able to reach its maximum transmission distance (FCC: 3.11 mi (5 km); CE / KCC / MIC / SRRC: 1.86 mi (3 km)) in a wide open area with no electromagnetic interference, and at an altitude of about 8.2 ft (2.5 m).

Installation



- Threadlocker of medium strength is required for installation. Apply threadlocker when mounting the landing gear, power port module, spray tank, sprinklers, and radar module. Ensure the threadlocker is totally dry and solid before flight.
- DO NOT bend the hoses in an arc tighter than their minimum bend radius during installation. This is to avoid creasing, which may compromise the spraying effect.
- Ensure that all installation and connection procedures are completed before powering on the aircraft.

The installation steps are the same for both the MG-1P and MG-1P RTK. In the figures below the MG-1P is shown.

Mounting the Landing Gear

1. Identify the landing gear leg containing the compass cable.
2. Take out the compass cable from the tube of the landing gear leg and connect it to the compass port on the aircraft's right side, then mount the right landing gear leg to the mounting position. Be careful not to damage the cable.
3. Secure the right landing gear leg in place using four M3×10 screws.

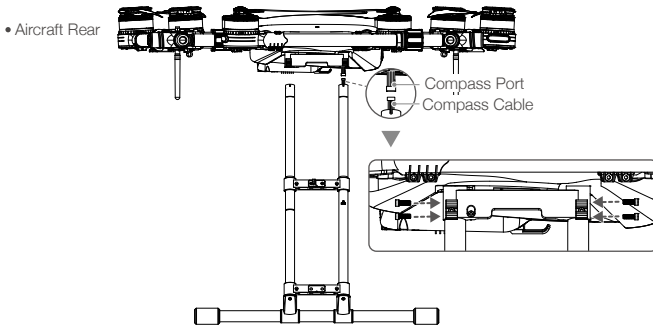

4. Mount the left landing gear leg and secure it in place using three M3×10 screws.

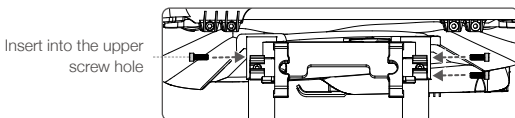

Mounting the Power Port Module

Mount the power port module onto the left landing gear leg using two M3×18 screws and one M3×22 screw.

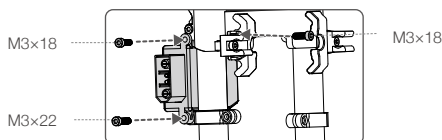

Mounting the Spray Tank

1. Connect the sprinkler kits to the spray tank: Pull the four hoses through the nuts to the outlets under the delivery pump, then tighten the nuts using a wrench. Note that the white and black hoses should be attached to outlets with labels of the same color. Be sure to securely tighten the nuts to avoid liquid leakage.

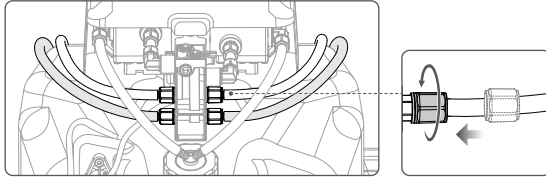

2. Remove the cover of the spray tank. Pull the hoses on both sides through the spaces between the two tubes of each landing gear leg with the mouth of the tank facing toward the right side of the aircraft.
3. Lift the spray tank and pull the mouth of the tank through the space between the two tubes of the right landing gear leg.

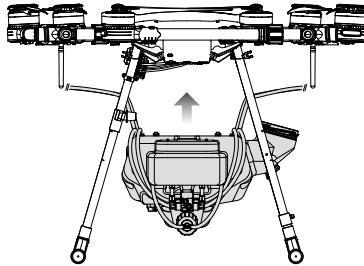

4. Insert the plugs on the left landing gear leg into the mounting holes on the spray tank.
5. Slide the fixing bracket on the right landing gear leg to the marks on the tubes to align the screw holes on the fixing bracket with the fin on the right side of the spray tank. Tighten the two M3x12 screws and insert and tighten one M3x10 (Plus) screw.

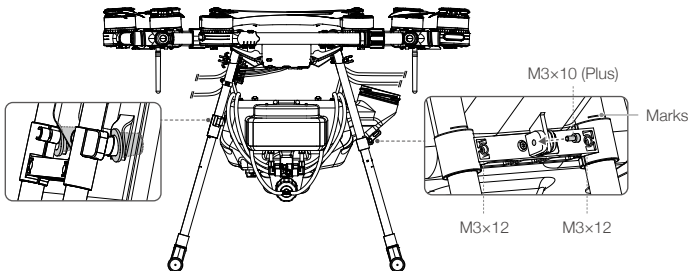

6. Connect the two pump cables and one liquid level meter cable to their corresponding ports on the aircraft body.

Unfolding the Frame Arms

1. Unfold the frame arms ① and tighten the two arm sleeves at each of the junctions ②.
2. Identify the position and rotational direction of the motors. The top view shows motors M1 to M8 arranged in a counter-clockwise order, with motors M1 and M2 at the front of the aircraft, and motors M5 and M6 at the rear. Motors M1, M3, M5, and M7 rotate counter-clockwise as indicated by the "CCW" mark, while motors M2, M4, M6, and M8 rotate clockwise as indicated by the "CW" mark.

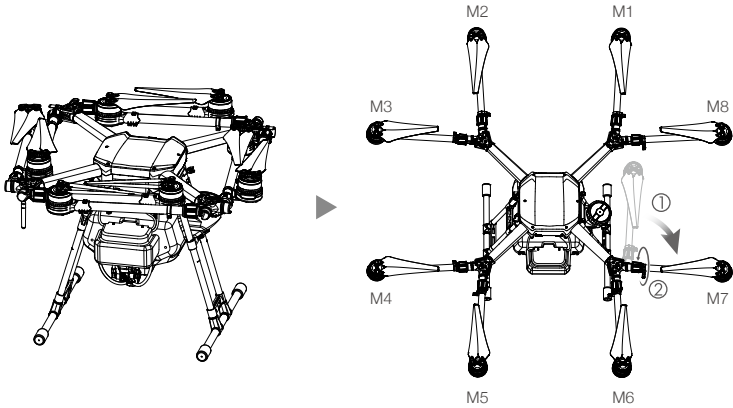

Mounting the Sprinklers

1. Mount the hose clips: Mount one hose clip to the bottom of each of the four frame arm junctions using T3x10 screws. Mount one hose clip to the outside of the right landing gear leg mounting position using an M3x6 screw.

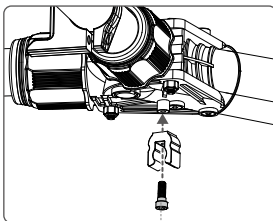

T3x10

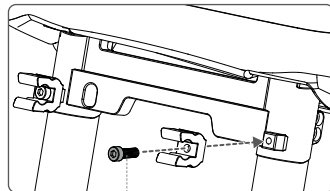

M3x6

2. Mount the sprinklers with white hoses under motors M3 and M8 (with white circle marks). Mount the sprinklers with black hoses under motors M4 and M7 (with black circle marks). Mount each of the four sprinklers using three M3x8 (Plus) screws, then insert the hoses into the clips at the bottom of the frame arm junctions. Be sure to mount the sprinklers to the mounting holes nearer to the inside of the aircraft, with the hoses facing the frame arm.

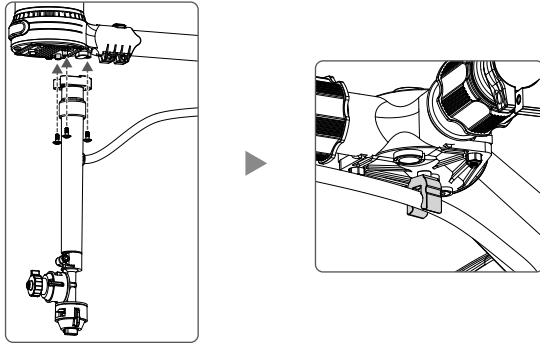

3. Insert the hoses on both sides into the clips on the landing gear.

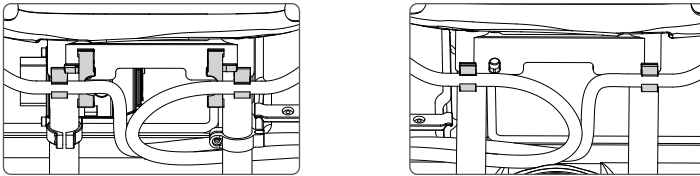

4. Mount the fender to the right landing gear leg to avoid spills when pouring liquids. Handle with care to avoid damage to the fender.

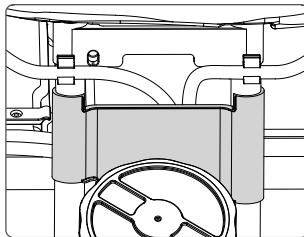

Mounting the Radar Module

1. Mount the radar bracket to the radar module using four M3×5.5 screws, with the bracket crossbar over the radar cable as shown in the figure below.

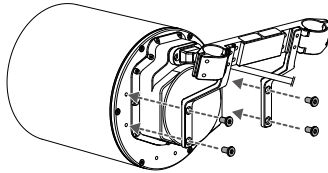

2. Unfasten the buckles on the bracket then mount it to the left landing gear leg. Align the bracket to the lower marks on the landing gear leg. Fasten the buckles and secure them using four M3×5.5 screws.

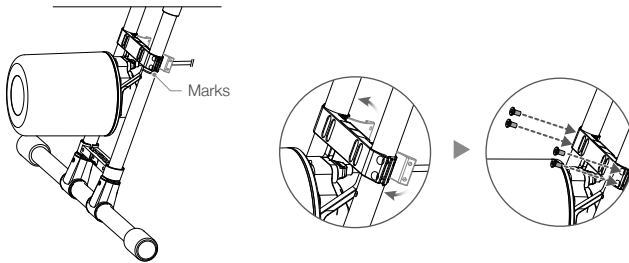

3. Insert the radar cable into the cable clip on the landing gear leg, then connect it to the radar port on the aircraft body.

Mounting the Flight Battery

Insert the battery into the battery compartment from the front of the aircraft. Ensure the battery is securely mounted and then fasten the belt to the stud on the spray tank.

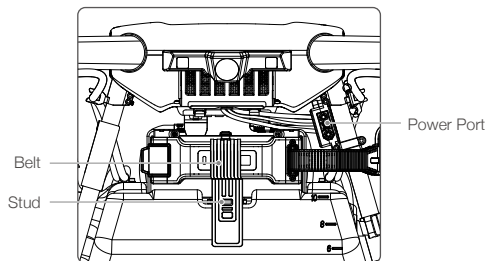



- The MG-1P and MG-1P RTK do not come with a battery. Please purchase the DJI approved MG-1P battery pack (Model: MG-12000P).
- The voltage on the aircraft can reach 50.4 V. Read the battery's safety guidelines and take necessary precautions when handling the battery to ensure your own safety.

Mounting the Remote Controller Battery

The remote controller uses a removable, interchangeable Intelligent Battery making long-term operation easy.

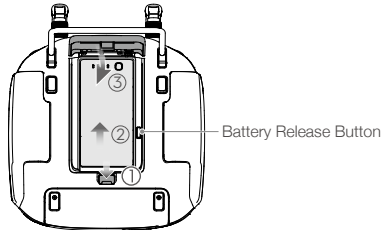
Slide the battery compartment cover lock on the back of the remote controller down to open the cover ①, insert the Intelligent Battery into the compartment and push it to the top ②, then close the cover ③.



 To remove the Intelligent Battery, open the cover, press and hold the battery release button, then push the battery downward.

Mounting the Dongle



- Only use a DJI approved dongle.
- The dongle supports various network standards. Use a SIM card that is compatible with the chosen mobile network provider and select a mobile data plan according to the planned level of usage.
- Use the dongle and the SIM card in accordance with their manuals.
- The dongle and SIM card are used to enable the remote controller to access to specific networks and platforms, such as the DJI Agriculture Management Platform. Be sure to mount them correctly, or else network access will not be available.

1. Lift the dongle compartment cover at the gap at its lower right corner, then remove it.
2. Insert the SIM card into the dongle and then insert the dongle into the USB port inside the compartment. Test to ensure that they function properly.*
3. Cut the connecting string between the dongle cap and dongle body if there is one.
4. Re-mount the dongle compartment cover. To secure the cover, open the silicone protectors on the cover, insert and tighten two M1.6×3 screws, then close the silicone protectors.

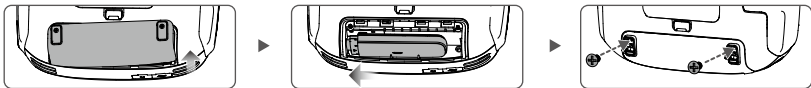

* Test procedure: Press the remote controller power button once, then press again and hold to turn the remote controller on. In the DJI MG app tap  and select **Network Diagnostics**. If the statuses of all the devices in the network chain are shown in green the dongle and SIM card are functioning properly.

Fly Safe

It is important to understand some basic flight guidelines, both for your protection and for the safety of those around you.

1. Flying in Open Areas: Do not fly near or above people or animals, or near buildings, power lines, or other obstacles.
2. Maintain Control at All Times: Always keep your hands on the remote controller and maintain control of your aircraft when it is in flight, even when using intelligent functions such as the Intelligent Operating Planning system, A-B Route operation mode, and Smart Return to Home.
3. Maintain Line of Sight: Maintain visual line of sight with your aircraft at all times and avoid flying behind buildings or other obstacles that may block your view.
4. Monitor Your Altitude: For the safety of manned aircraft and other air traffic, always fly at altitudes lower than 98 feet (30 meters) and in accordance with all local laws and regulations.



Visit <https://www.dji.com/flysafe> for more information on critical safety features such as GEO Zones.

Calibrating the Compass

Ensure the compass is calibrated before every flight. Failure to do so may lead to unexpected flight behavior.

1. DO NOT calibrate your compass where magnetic interference may occur, such as locations close to magnetite deposits or large metallic structures such as parking structures, steel-reinforced basements, bridges, cars, or scaffolding.
2. DO NOT carry objects (such as cell phones) that contain ferromagnetic materials near the aircraft during calibration.
3. The compass should always be calibrated when moving from indoor spaces to outdoor spaces.
4. If the Aircraft Status Indicators blink red and yellow alternately after placing the aircraft on the ground, the compass has detected magnetic interference. Change your location.
5. If the Aircraft Status Indicators blink red the calibration has failed. Change your location and try the calibration procedure again.

Flying Considerations

1. DO NOT use the aircraft in adverse weather conditions such as heavy rain (precipitation rate exceeding 25 mm or 0.98 inches in 12 hours), winds exceeding 17 mph (28 kph), fog, snow, and lightning.
2. Only fly in open areas. Tall buildings and steel structures may affect the accuracy of the onboard compass and GNSS signal.
3. DO NOT fly near sources of strong electromagnetic radiation such as power lines, mobile phone base stations, electrical substations, and radio transmission towers.
4. Aircraft and battery performance is subject to environmental factors such as air density and temperature. Be very careful when flying over 6,560 feet (2 km) above sea level as the battery and aircraft performance may be reduced.
5. In the Earth's polar regions the aircraft can only operate in Attitude mode.
6. Ensure that there is a strong GNSS signal when operating.

Return to Home (RTH)

It is important to take off with a strong GNSS signal to ensure that the Home Point is recorded by the aircraft. The aircraft will automatically return to the Home Point in the following cases.

Smart RTH: You press the RTH button.

Failsafe RTH*: The remote controller signal is lost.

During RTH, if there is an obstacle within 20 m of the aircraft, the aircraft decelerates and then stops and hovers. While decelerating, if the aircraft comes within 6 m of the obstacle it flies backward to a distance of around 6 m from the obstacle and hovers. The aircraft then exits the RTH procedure and waits for pilot commands.

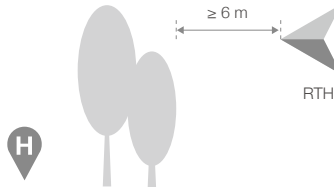

* If Failsafe RTH is disabled (the default setting in the DJI MG app) the aircraft hovers in place when the remote controller signal is lost.



Obstacle avoidance is disabled in Attitude mode (which the aircraft enters in situations such as when the GNSS signal is weak) and is not available if the operating environment is not suitable for the radar module, so extra caution is required in such situations.

Pesticide Usage

1. Avoid the use of powder pesticides as much as possible as they may reduce the service life of the spraying system.
2. Pesticides are poisonous and pose serious risks to human safety. Use them in strict accordance with their specifications.
3. Residue on the equipment caused by splashes or spills when pouring or mixing the pesticide can irritate your skin. Be sure to clean the equipment after pouring or mixing.
4. Use clean water to mix the pesticide to avoid blocking the strainer. Clear any blockages before using the equipment.
5. Wear protective clothing to prevent direct body contact with the pesticide. Always rinse your hands and skin after handling pesticides. Clean the aircraft and remote controller after applying the pesticide.
6. Effective use of pesticides relies on pesticide density, spray rate, spray distance, aircraft speed, wind speed, and wind direction. Consider all factors when using pesticides, but never compromise the safety of people, animals, or the environment in doing so.
7. DO NOT contaminate rivers or sources of drinking water.



It is important to understand basic flight guidelines, for the safety of both you and those around you. Do not forget to read the *Agras MG-1P / MG-1P RTK Disclaimer and Safety Guidelines*.

Using the MG-1P / MG-1P RTK

Preparing the Flight Battery

Only use DJI approved flight batteries (Model: MG-12000P). Check the battery level before flying and charge according to the instructions provided by the manufacturer.

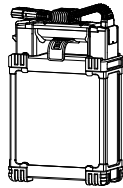

Model: MG-12000P

Preparing the Remote Controller

Checking Battery Level

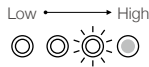
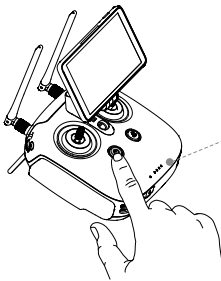

Press once to check the battery level. Press once, then again and hold to turn on/off.

Charging the Battery

The remote controller uses a removable Intelligent Battery. Press the battery level button once to check the battery level. Fully charge the batteries before first-time use.

Place the battery into the Charging Hub, connect the AC power adapter to the Charging Hub, and then connect the AC power adapter to a power outlet (100 - 240V, 50/60Hz).

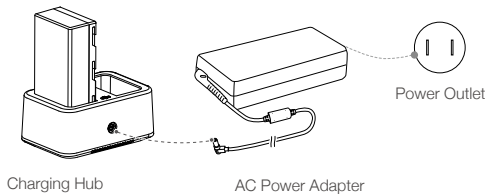

Adjusting the Antennas

Tilt the display device on the remote controller to the desired position, then adjust the antennas so they are facing outward. The strength of the remote controller signal is affected by the position of the antennas.

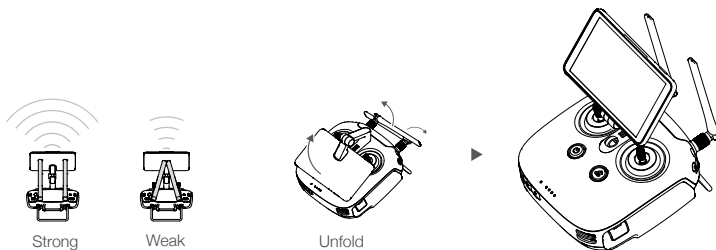

Try to keep the aircraft inside the optimal transmission zone. If the signal is weak, adjust the antennas or fly the aircraft closer.

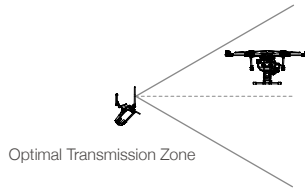

Avoid using wireless devices that use the same frequency bands as the remote controller.

Getting Ready for Takeoff

When using your MG-1P / MG-1P RTK for the first time activate it using the DJI MG app. Your DJI account and an Internet connection are required.

1. Place the aircraft on an open, flat ground with the Aircraft Status Indicators facing toward you.
2. Unfold the propellers and check that they are mounted onto the motors securely. Unfold the frame arms and tighten the arm sleeves firmly.
3. Power on the remote controller.
4. Ensure the battery is securely mounted. Connect the battery to the power port on the aircraft.

Calibrating the Compass

1. Go to the app and tap **Perform an Operation** to enter Operation View. Tap the Aircraft Status Bar at the top of the screen and select **Calibration** in the Aircraft Status List, then follow the on-screen instructions.
2. Hold the aircraft horizontally and rotate it 360 degrees around a vertical axis until the Aircraft Status Indicators change to solid green and the display goes to the next step in the app.
3. Hold the aircraft vertically, with its nose pointing upward, and rotate it 360 degrees around a vertical axis.

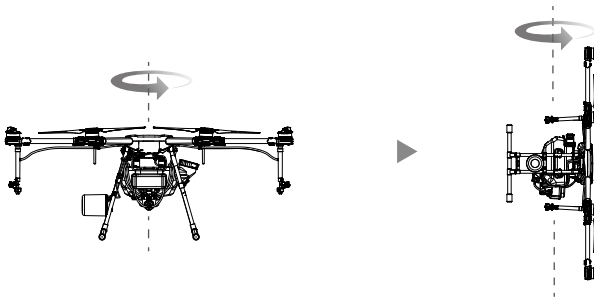

4. The Aircraft Status Indicators show the current flight mode and the calibration page disappears in the app when calibration is complete. If the Aircraft Status Indicators blink red or a calibration failure is displayed in the app, repeat the steps above to calibrate the compass.

Calibrating the Spraying System

Be sure to calibrate the spraying system before your first spray operation, or else it will adversely affect spraying performance. Use the included measuring cup to ensure accuracy. Calibration takes around 6 to 14 minutes.

1. Preparation before calibration: If there are any bubbles in the hoses, discharge them before calibrating. If there are no bubbles proceed directly to calibration.
 - ① Fill the spray tank with about 2 L of water.
 - ② Power on the remote controller and the aircraft.
 - ③ Loosen the four manual relief valves on the side of the sprinklers and press the Spray button on the remote controller until the bubbles in the hoses have been fully discharged.* Tighten the valves and press the Spray button to stop spraying.

* If the bubbles have still not been fully discharged after a long period of time, rotate the valve cover and remove it, then re-mount the cover once the bubbles have been fully discharged.

2. Spraying System Calibration

① Liquid level meter calibration

Pour about 1 L of water into the spray tank. In the DJI MG app go to Operation View > ●●● > , then tap **Calibrate** in Flow IMU settings.

Select **Nozzle Model**, select the correct model in the list (the standard nozzle is model XR11001VS), then tap **Start Calibration**. The aircraft will spray automatically, then when ready the app will indicate that the aircraft is ready for left pump calibration.

② Left pump calibration

Pour between 1 and 5 L of water into the spray tank, measuring the volume of water precisely using the measuring cup.

In the app, input the volume of the water you have poured into the tank. Be sure to input the precise value to avoid calibration bias. Tap **Start Calibration** and the aircraft will spray automatically, then when ready the app will indicate that the aircraft is ready for right pump calibration.

③ Right pump calibration

Repeat the procedure described above for right pump calibration. Once the app indicates that right pump calibration is complete, wait for a few more moments until the app indicates that the spraying system calibration procedure is totally complete.

3. Discharge any bubbles in the hoses using the same procedure as used when preparing for calibration.

Flight

In the DJI MG app go to Operation View. Ensure that there is a strong GNSS signal, otherwise the aircraft cannot take off.

Takeoff

Perform a Combination Stick Command (CSC) and then slowly push the throttle stick up to take off.

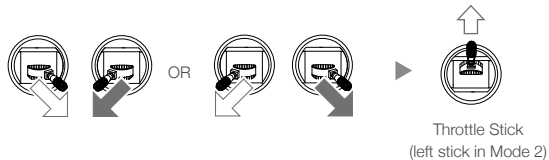

Landing

To land, pull down on the throttle stick to descend until the aircraft touches the ground. There are two methods to stop the motors.

Method 1: When the aircraft has landed, push and hold the throttle stick down. The motors will stop after 3 seconds.



Throttle Stick

Method 2: When the aircraft has landed, push the throttle stick down, then perform the same CSC that was used to start the motors. Release both sticks once the motors have stopped.

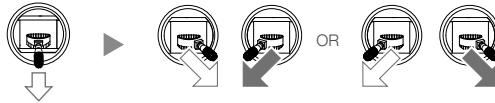

Throttle Stick



- Take off immediately once the motors have started spinning, or else the aircraft may drift and injure nearby people.
- Spinning propellers can be dangerous. Stay away from spinning propellers and motors. DO NOT start the motors in confined spaces or when there are people nearby.
- Always keep your hands on the remote controller when the motors are spinning.
- Never stop the motors mid-flight unless in an emergency situation and if doing so will reduce the risk of damage or injury.
- Method 1 is the recommended method for stopping the motors. When using Method 2 to stop the motors, the aircraft may roll over if it isn't completely on the ground. Use Method 2 with caution.
- After landing, power off the aircraft before turning off the remote controller.

Using the Intelligent Operation Planning System

The remote controller is equipped with a screen with a built-in Android system which can run the DJI MG app. The Intelligent Operation Planning system built-in to the app can be used to measure the operation area, identify obstacles, configure waypoints, set aircraft settings, and produce flight route plans. Once flight routes have been planned, they can be used to command the aircraft to fly routes automatically.

Planning Field

The DJI MG app supports flight route planning either by walking to waypoints, obstacles, and calibration points carrying the remote controller or by flying the aircraft to these points. The following description takes planning using the aircraft as an example.



Power on the spraying system remote controller, then the aircraft



Tap **Plan a Field** > Fly the aircraft



The app will display **Manual Route (GNSS)** or **Manual Route (RTK)**



Tap **Start Measuring**



Fly the aircraft alongside the boundary of the operation area and tap **Add Waypoint** at turning points



Fly near to each obstacle* in turn and tap **Start Obstacle Measurement**



Fly the aircraft around the obstacle and tap **Add Waypoint** at several points around the obstacle*



Tap **End Obstacle Measurement***



Fly to the location of each calibration point and tap **Add Calibration Point**



Tap **End Measurement**



Adjust the flight route: route angle, line spacing, and collision avoidance safety margin



Save the field

* If any obstacles exist in the operation area.

Once you have finished planning tap **dji** in the upper left corner of the screen to return to the main screen.



- Operate the aircraft carefully when flying near obstacles to avoid collision.
- Calibration points are used to rectify flight route biases caused by GNSS positioning deviations. Choose one or more fixed reference points for calibration like a metal peg or obvious marker that is easy to identify for bias rectification when using the plan.

Starting an Operation



Take the aircraft to one of the calibration points



Tap **Perform an Operation** in the app main screen



Tap , select the field from the field list and select **Use**



Adjust the flight route: route angle, line spacing, and collision avoidance safety margin



Tap **Rectify Offset**



Tap **Perform an Operation**



Set the operation parameters, then confirm



Slide the slider to start the operation



- Only take off in open areas.
- An operation can be paused by toggling the Pause switch. The aircraft will hover and record the breakpoint, and then the aircraft can be controlled manually. To continue the operation, tap **Resume** in the app and the aircraft will return to the breakpoint automatically and resume the operation.
- The aircraft will hover at the end point of the flight route once the operation is complete. Instead of hovering the aircraft can also be set to perform other flight actions in the app.

More Operation Modes

Refer to the *Agras MG-1P / MG-1P RTK User Manual* for details about the A-B Route, Manual, and Manual Plus operation modes.

More Functions



Operation Resumption



System Data Protection



Empty Tank Warning

Refer to the *Agras MG-1P / MG-1P RTK User Manual* for details.

Specifications

Airframe	
Diagonal Wheelbase	1500 mm
Frame Arm Length	619 mm
Dimensions	MG-1P: 1460 × 1460 × 578 mm (Frame arms unfolded, propellers removed) 780 × 780 × 578 mm (Frame arms folded)
	MG-1P RTK: 1460 × 1460 × 616 mm (Frame arms unfolded, propellers removed) 780 × 780 × 616 mm (Frame arms folded)
Propulsion System	
Motors	
Stator Size	60 × 10 mm
KV	130 rpm/V
Max Thrust	5.1 kg/rotor
Max Power	770 W
Weight (With cooling fan)	255 g
ESCs	
Max Allowable Current (Continuous)	25 A
Operating Voltage	50.4 V (12S LiPo)
Signal Frequency	30 to 450 Hz
Drive PWM Frequency	12 kHz
Foldable Propellers (21/21R)	
Material	High-performance engineered plastics
Diameter × Pitch	21 × 7 inch
Weight	58 g
Spraying System	
Spray Tank	
Volume	10 L
Standard Operating Payload	10 kg
Max Battery Size	151 × 195 × 70 mm
Sprinkler Kits	
Model	XR11001VS
Quantity	4
Max Spray Rate	0.45 L/min (Single nozzle, using water)
Spray Width	4 to 6 m (4 nozzles, 1.5 to 3 m above vegetation)
Droplet Size	XR11001VS: 130 - 250 µm (Depending on operating environment and spray rate)
High-Precision Radar Module	
Model	RD2412R
Operating Frequency	CE / FCC / SRRC (China): 24.00 GHz to 24.25 GHz MIC (Japan) / KCC (Korea): 24.05 GHz to 24.25 GHz

Power Consumption	12 W
EIRP	CE / FCC / MIC / KCC: 20 dBm; SRRC: 13 dBm
Field of View (FOV)	Horizontal: 50°, Vertical: 10°
Altitude Detection and Stabilization	Detection Range: 1 to 30 m Stabilization Working Range: 1.5 to 10 m
Obstacle Avoidance System	Sensing Range: 1.5 to 30 m (varies according to the material, position, shape, and other properties of the obstacle) Operating Conditions: Flying higher than 1.5 m over the obstacle with speed lower than 7 m/s Safety Distance: 2.5 m Obstacle Avoidance Direction: Forward or backward
IP Rating	IP67
FPV Camera	
FOV	123° (H)
Resolution	1280x960 30p
Flight Parameters	
Operating Frequency	2.400 GHz to 2.483 GHz 5.725 GHz to 5.850 GHz (not supported in Japan)
EIRP	2.4 GHz FCC: < 26 dBm; CE / MIC / KCC / SRRC: < 20 dBm 5.8 GHz FCC / SRRC: < 26 dBm; CE / KCC: < 14 dBm
Total Weight (Excluding battery)	MG-1P: 9.8 kg, MG-1P RTK: 9.9 kg
Standard Takeoff Weight	MG-1P: 23.8 kg, MG-1P RTK: 23.9 kg
Max Takeoff Weight	24.8 kg (At sea level)
Max Thrust-Weight Ratio	1.71 (Takeoff weight of 23.8 kg)
Hovering Accuracy (Strong GNSS signal)	D-RTK enabled: horizontal ±10 cm, vertical ±10 cm D-RTK disabled: horizontal ±0.6 m, vertical ±0.3 m (±0.1 m, radar module enabled)
GNSS*	GPS+GLONASS
Battery	DJI approved battery pack (Model: MG-12000P)
Max Power Consumption	6400 W
Hovering Power Consumption	3800 W (Takeoff weight of 23.8 kg)
Hovering Time*	20 min (Takeoff weight of 13.8 kg with a 12000 mAh battery) 9 min (Takeoff weight of 23.8 kg with a 12000 mAh battery)
Max Operating Speed	7 m/s
Max Flying Speed	10 m/s (P-mode), 15 m/s (A-mode)
Max Wind Resistance	8 m/s
Max Service Ceiling Above Sea Level	2000 m
Operating Temperature	32° to 104° F (0° to 40° C)

* For the Asia-Pacific version of the MG-1P RTK, GNSS is GPS+GLONASS+BEIDOU when RTK is enabled. Estimated hovering time was measured at sea level and in wind speeds under 3 m/s. This value should be used for reference only.

Remote Controller	
Model	GL300N
Operating Frequency	2.400 GHz to 2.483 GHz 5.725 GHz to 5.850 GHz (not supported in Japan)
Max Transmitting Distance (unobstructed, free of interference)	FCC: 3.11 mi (5 km) CE / MIC / KCC / SRRC: 1.86 mi (3 km)
EIRP	2.4 GHz FCC: < 26 dBm; CE / MIC / KCC / SRRC: < 20 dBm 5.8 GHz FCC / SRRC: < 26 dBm; CE / KCC: < 14 dBm
Display Device	5.5 inch screen, 1920x1080, 1000 cd/m ² , Android system, 4G RAM+16G ROM
Supported SD Cards	microSD. Max Capacity: 128GB
Power Consumption	16 W (typical value)
Operating Temperature	14° to 104° F (-10° to 40° C)
Storage Temperature	Less than 3 months: -4° to 113° F (-20° to 45° C) More than 3 months: 72° to 82° F (22° to 28° C)
Charging Temperature	41° to 104° F (5° to 40° C)
Remote Controller Intelligent Battery	
Model	WB37-4920mAh-7.6V
Battery Type	LiPo battery
Capacity	4920 mAh
Voltage	7.6 V
Energy	37.39 Wh
Charging Temperature	41° to 104° F (5° to 40° C)
Charging Hub	
Model	WCH2
Input Voltage	17.3 - 26.2 V
Output Voltage and Current	8.7 V, 6 A; 5 V, 2 A
Operating Temperature	41° to 104° F (5° to 40° C)
AC Power Adapter	
Model	A14-057N1A
Voltage	17.4 V
Rated Power	57 W

DJI Support
<http://www.dji.com/support>

※ This Quick Start Guide is subject to change without prior notice.

Download the user manual for more information:
<http://www.dji.com/mg-1p>



AGRAS is a trademark of DJI.
Copyright © 2018 DJI All Rights Reserved.

Printed in China.