

# T Series Spreading System

User Guide

使用说明

v1.0 2020.03

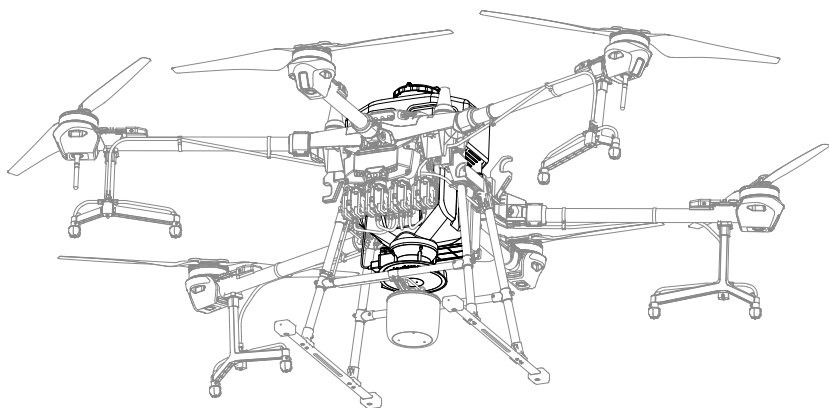

## Disclaimer

Carefully read this entire document and all safe and lawful practices provided by DJI™ before using this product for the first time. Failure to read and follow instructions and warnings may result in serious injury to yourself or others, damage to your DJI product, or damage to other objects in the vicinity. By using this product, you hereby signify that you have read this disclaimer carefully and that you understand and agree to abide by the terms and conditions herein. You agree that you are solely responsible for your own conduct while using this product, and for any consequences thereof. DJI accepts no liability for damage, injury, or any legal responsibility incurred directly or indirectly from the use of this product.

DJI is a trademark of SZ DJI TECHNOLOGY CO., LTD. and its affiliated companies. Names of products, brands, etc., appearing in this document are trademarks or registered trademarks of their respective owner companies. This product and document are copyrighted by DJI with all rights reserved. No part of this product or document shall be reproduced in any form without the prior written consent of or authorization from DJI.

This disclaimer is available in various languages. In the event of divergence among different versions, the English version shall prevail. The final interpretation of this document and all related documents of this product belongs to DJI. This content is subject to change without prior notice. For up to date product information, visit <http://www.dji.com> and click on the product page for this product.

## Warnings

1. The T Series Spreading System (abbreviated as Spreading System) is only compatible with the DJI AGRAS™ T series aircraft, and the firmware of the aircraft must be the correct version for supporting the Spreading System. Refer to the Specifications section for more information about compatible aircraft. DO NOT use it with other products or for purposes other than agriculture.
2. The Spreading System is compatible with dry materials of a diameter between 0.5 - 5 mm. DO NOT use with other materials. If used with other materials, the operating performance will be negatively affected and the Spreading System may be damaged. All materials must be used in strict accordance with the instructions for those materials.
3. The max internal spread tank load depends on the takeoff weight of the aircraft. DO NOT overload. Refer to the Specifications section for more information.
4. When connecting the cables, make sure the connection is correct and secure. Operate with caution to avoid damaging the cables.
5. Make sure that the hopper gate and spinner disk function normally before each use.
6. Operate with caution to avoid injury caused by mechanical parts.
7. When spreading is in progress, maintain a safe distance from the Spreading System to avoid injury.
8. When spreading is in progress, the minimum detection distance of the radar module will be 5 m instead of 1.5 m due to obstruction from the materials being spread. Note that the aircraft cannot sense obstacles that are not within the detection range. The detection performance of the radar module will also decrease. Fly with caution. Refer to the disclaimer and safety guidelines of the corresponding aircraft you are operating for more information on the radar module.
9. DO NOT use liquids to rinse the Spreading System. It is recommended to use dry compressed air as a cleaning agent.

## Introduction

The T Series Spreading System is compatible with Agras T series aircraft and offers efficient, reliable, and stable spreading operations. The material delivery system is precisely controlled by the built-in stirring device and hopper

gate, which can prevent material blockages and improve operating accuracy and reliability.

Use the app compatible with your aircraft to set parameters such as the hopper outlet size and spinner disk rotating speed. These parameters can be adjusted to meet different requirements. The app provides warning prompts for an empty tank as well as for abnormalities in the rotating speed, temperature, and hopper outlet size. These prompts help ensure system safety.

The Spreading System has two versions, 1.0 and 2.0. They each have a different structure for the spinner disk. Compared with the Spreading System 1.0, the Spreading System 2.0 has a higher material delivery rate and can spread materials 360° around the aircraft. Unless otherwise specified, the descriptions in this document use the Spreading System 1.0 as an example.

## In the Box

Spreading System × 1

Spare Spinner Disk × 2

M4×12 Screws × 2

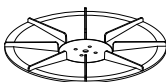

Users have the option to purchase a fender with a screw pack to use with the Spreading System 2.0.

## Overview

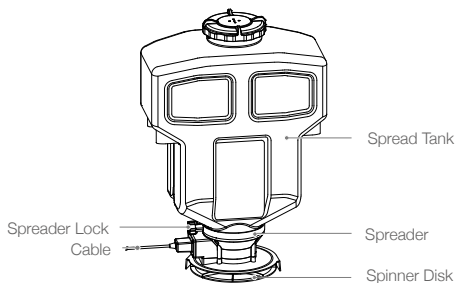

## Installation

Make sure to remove the Intelligent Flight Battery from the aircraft before installation. Hex keys for M2.5, M3 and M4 screws are required for installation.

1. Lift and remove the spray tank on the aircraft.

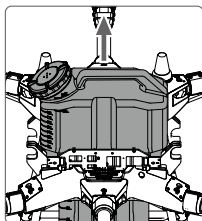

2. Remove all of the rubber stoppers and five M3×8 screws on the upper cover on the front of the aircraft, and then remove the upper cover. For the T20 aircraft, the cable strainer protector on the left must also be removed.

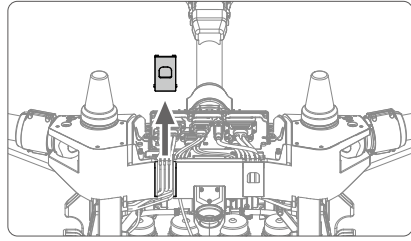
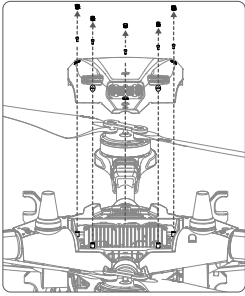

3. Locate the EMF/Liquid Level port on the spray control board. Remove the M2.5×8 screws on the cable connector, and then unplug the cable and place it in the space near the aircraft frame. The location and structure of the spray control board are different on the T20 and T16. Refer to the figures below for more information.

T20

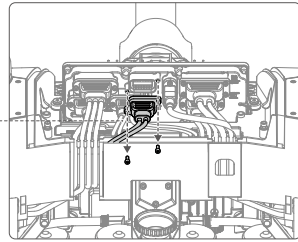
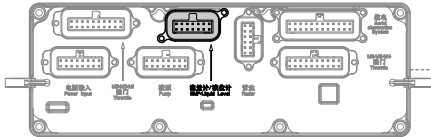

T16

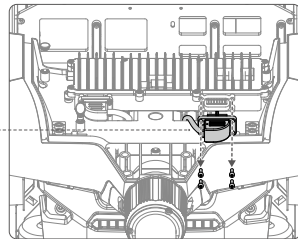
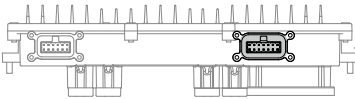

4. Detach the spread tank and the spreader: Pull the spreader lock knob out, rotate it 90°, and release. Next, rotate the spreader to detach it.

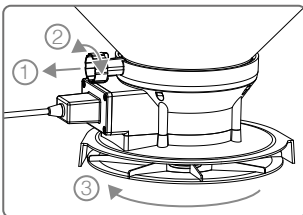

Locked

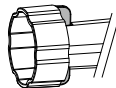

Unlocked

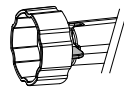

5. For the Spreading System 2.0, there is the option to mount the fender to the spreader. If mounted, the fender will prevent materials from being spread to the rear of the aircraft.

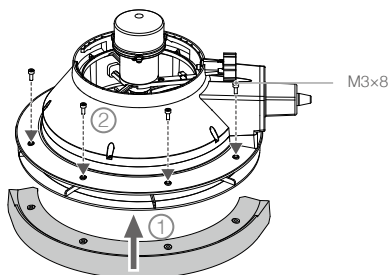

6. Connect the Spreading System cable:

T20

Pass the cable through the space between the delivery pumps and spread tank mounting position. Secure the cable to the cable strainer on the left of the aircraft, connect it to the EMF/Liquid Level port, and tighten the two M2.5x8 screws.

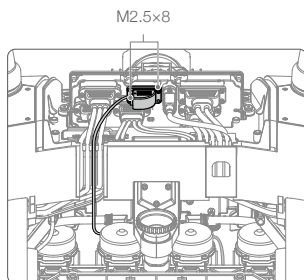

T16

- Remove the M3x8 screws on both sides of the spray control board. Lift the board gently to make a space between the board and the mounting position. **DO NOT** pull the cables connected on the board.
- Pass the cable through the space between the delivery pumps and spread tank mounting position, then through the space under the spray control board. Connect the cable to the EMF/Liquid Level port and tighten the four M2.5x8 screws.
- Remount the M3x8 screws on both sides of the spray control board.

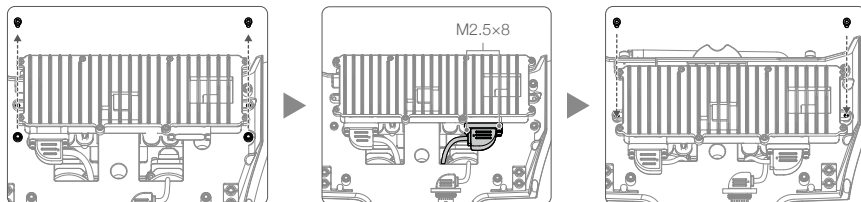

7. Remount the cable strainer protector (for T20 only) and the upper cover of the aircraft. Tighten the five M3x8 screws and attach all of the rubber stoppers.

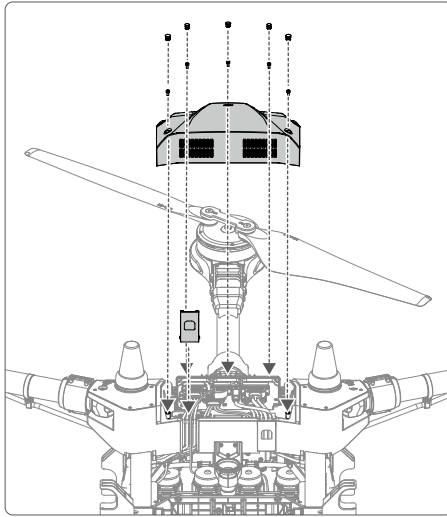

8. Insert the spread tank in the aircraft. **DO NOT** insert it to the bottom of the aircraft frame. Make sure that the middle of the tank is approximately 5 cm from the middle frame of the aircraft, as shown in the figure below.

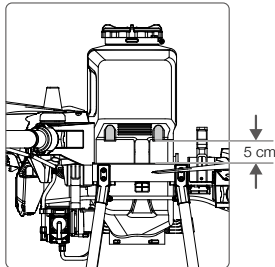

9. Mounting the spreader:

- Face the rear of the aircraft and check the spreader lock knob is in an unlocked position. Insert the spreader with the knob located to the left of the circular indentation on the spread tank.
- Rotate the spreader to mount it to the spread tank. To lock the spreader, pull the spreader lock knob out, rotate it 90°, and release. Make sure that the spreader is locked in position.

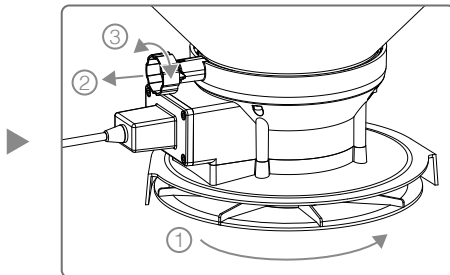
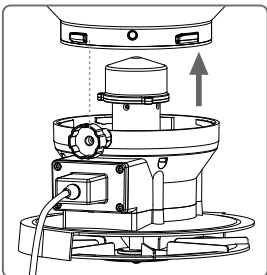

- Secure the Spreading System cable to the landing gear using the Velcro on the cable.

10. Insert the spread tank to the bottom of the aircraft frame and make sure it is in position. Insert and tighten two M4×12 screws to the rear of the tank.

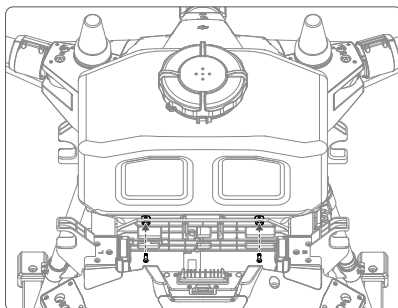

 Operate with caution to avoid injury caused by mechanical parts.

## Usage

1. Rotate the cover to open, add compatible materials, and tighten the cover.
2. Power on the remote controller, and then power on the aircraft.
3. Enter Operation View in the app. The following descriptions use the DJI Agras app as an example.
4. Tap the hopper outlet size display on the left of the screen to set the hopper outlet size, spinner disk rotating speed, flying speed, line spacing, height relative to the vegetation, and banked turning. Adjustable parameters vary depending on the operation mode. Adjust the settings so that they are suitable for the materials you are using and test to make sure the performance is as expected.

For the Spreading System 1.0, when measuring between 7.5 to 9 kg/ha of materials spread, it is recommended to:

- Adjust the hopper outlet size so that the material delivery rate is 1 kg/min.
- Adjust the spinner disk rotating speed so that the spreading range is 4 to 6 meters.
- Set the flying speed to 4 m/s (flying speed setting is unavailable in Manual Operation Mode).

For the Spreading System 2.0, when measuring 45 kg/ha of materials spread, it is recommended to:

- Adjust the hopper outlet size so that the material delivery rate is 8 kg/min.
- Adjust the spinner disk rotating speed so that the spreading range is 5 to 7 meters.
- Set the flying speed to 5 m/s (flying speed setting is unavailable in Manual Operation Mode).

5. Enter the operation mode required for spreading. The operations of the Spreading System vary depending on the operation mode.

### Route Operation Mode

After starting an operation, the aircraft ascends to an altitude of 4 meters and the spinner disk spins. When the aircraft reaches the route starting point, the hopper gate opens according to the set value and the aircraft flies along the route and spreads material automatically. Spreading cannot be started or stopped manually.

The operation resumption function can be used during operation. Once the operation is paused, the hopper gate closes automatically to stop spreading while the spinner disk is still spinning. After operation is resumed, the aircraft returns to the breakpoint or projection point and continues spreading.

## A-B Route Operation Mode

After the aircraft enters A-B Route Operation Mode, the spinner disk spins. When the aircraft reaches the first turning point, the hopper gate opens according to the set value and the aircraft flies along the route and spreads material automatically. Spreading cannot be started or stopped manually.

The operation resumption function can be used during operation. Once the operation is paused, the hopper gate closes automatically to stop spreading while the spinner disk is still spinning. After operation is resumed, the aircraft returns to the breakpoint or projection point and continues spreading.

## Manual Plus Operation Mode

Switch to M+ after the aircraft takes off. Press the Spray button on the remote controller to start the spinner disk. The hopper gate opens according to the set value and the aircraft spreads material automatically once it has begun flying.

## Manual Operation Mode

Switch to M after the aircraft takes off. Use the Spray button on the remote controller to start or stop spreading.

 In all operation modes except Manual Operation Mode:

- When the aircraft flies forward or backward, the hopper gate opens automatically to start spreading.
- When the aircraft flies left or right, the hopper gate closes automatically to stop spreading while the spinner disk continues to spin.

# Spreading System Calibration

## When to Calibrate

The Spreading System has been calibrated before delivery. There is no need to calibrate before using for the first time. Calibration is required in any of the following cases:

- The hopper gate cannot fully open or close.
- The material delivery rate is different from the desired value.
- The app incorrectly displays empty tank warnings.

## Calibration Procedure

In the app, enter Operation View. Tap  ,  , then tap Calibration in Spreading System Settings. Wait until the app indicates calibration is complete. If calibration fails, try again.

# Maintenance

1. Clean the residue inside the spread tank and spreader regularly. It is recommended to use dry compressed air and a clean, soft dry cloth. DO NOT rinse with liquids.
2. The spinner disk is a consumable part. If obvious signs of wear are noticeable, follow the steps below to replace the spinner disk.
  - a. Make sure that the aircraft is powered off, and then unplug the Spreading System cable.
  - b. Detach the spreader.
  - c. Remove the nut, washer, four M3x8 screws, and spinner disk at the bottom of the spreader. Mount a new spinner disk and secure it using the washers, M3x8 screws, and nut.



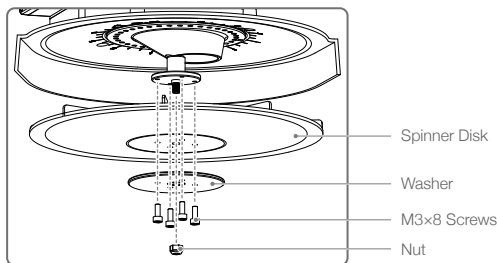

d. Remount the spreader to the spread tank. Make sure that the spreader is locked in position.

 Operate with caution to avoid injury caused by mechanical parts.

## Specifications

Items	Spreading System 1.0	Spreading System 2.0
Compatible Aircraft*	Agras T16, T20	
Spreader Weight	1.8 kg	2.1 kg (excluding fender)
Max Hopper Outlet Area	8.6 cm <sup>2</sup>	32.3 cm <sup>2</sup>
Compatible Material Diameter	0.5 - 5 mm	
Spread Tank Volume	20 L	
Spread Tank Internal Load	Using with the T16: 16 kg Using with the T20: 20 kg (note: the internal load of Japan version of T20 is 16 kg)	
Spreading Range	Varies according to material diameter, spinner disk rotating speed, hopper outlet size, and flying altitude. For best operating performance, it is recommended to adjust the corresponding variables to achieve a spreading range of 4 - 6 meters (for Spreading System 1.0) or 5 - 7 meters (for Spreading System 2.0).	

\* The firmware of the aircraft must be the correct version for supporting the Spreading System. Check the release notes of the corresponding aircraft on the official DJI website.

The content is subject to change without prior notice.

Download the latest version from  
<http://www.dji.com/t20>

AGRAS and © are trademarks of DJI.  
 Copyright © 2020 DJI All Rights Reserved.

## 免责声明

使用本产品之前，请仔细阅读并遵循本文及大疆™ 创新（DJI™）提供的所有安全指引，否则可能会给您和周围的人带来伤害，损坏本产品或其它周围物品。一旦使用本产品，即视为您已经仔细阅读本文档，理解、认可和接受本声明全部条款和内容。您承诺对使用本产品以及可能带来的后果负全部责任。大疆创新（DJI）对于直接或间接使用本产品而造成的损坏、伤害以及任何法律责任不予负责。

DJI 是深圳市大疆创新科技有限公司及其关联公司的商标。本文出现的产品名称、品牌等，均为其所属公司的商标。本产品及手册为大疆创新版权所有。未经许可，不得以任何形式复制翻印。

本文档及本产品所有相关的文档最终解释权归大疆创新（DJI）所有。如有更新，恕不另行通知。请访问 [www.dji.com](http://www.dji.com) 官方网站以获取最新的产品信息。

## 注意事项

1. T 系列播撒系统（简称“播撒系统”）仅适用于大疆农业 T 系列植保无人机（具体机型见“规格参数”），且需配合支持播撒系统的飞行器固件使用。切勿在其他产品上使用或用于农业植保以外的用途。
2. 播撒系统适合使用颗粒直径为 0.5 - 5 mm 的干燥物料。切勿使用其他物料，否则将影响作业效果，甚至损坏播撒系统。使用时，严格按照物料本身的使用说明进行操作。
3. 播撒系统作业箱最大载重与飞行器起飞重量有关，详见“规格参数”。切勿超重使用。
4. 连接线材时，确保正确牢固，小心操作，以免损坏线材。
5. 每次使用前，检查仓门开合是否顺畅，播撒盘运转是否正常。
6. 使用时务必小心，谨防机械结构伤手。
7. 进行播撒作业时，务必远离播撒系统，以免造成人身伤害。
8. 进行播撒作业时，由于播撒颗粒的遮挡，雷达模块的最小检测距离将由 1.5 米变为 5 米。如有障碍物处于探测范围以外，则飞行器无法感知障碍物。同时，雷达模块的检测性能亦有所减弱，务必谨慎飞行。更多雷达模块注意事项请参考对应飞行器的《免责声明和安全操作指引》。
9. 禁止水洗。建议使用干燥的压缩空气进行清洁。

## 简介

播撒系统是一款适用于大疆农业植保无人机的配件，将其安装至飞行器，可完成高效、可靠、稳定的播撒作业。内置搅拌装置及落料口仓门控制结构，精准控制落料速率，并有效防止落料堵塞，提高作业准确度及可靠性。

用户可通过与飞行器配套使用的 App 设置仓口大小、播撒盘转速等，满足不同作业场景的使用需求。App 可提示无料报警及转速、温度、仓口大小等参数异常报警，确保系统安全运行。

播撒系统分为 1.0 和 2.0 版本，其播撒盘结构有所不同。与播撒系统 1.0 相比，播撒系统 2.0 具有更大的落料速率，且可以在飞行器水平方向上 360° 范围内播撒物料。若无特殊注明，本文均以播撒系统 1.0 为例进行说明。

## 物品清单

播撒系统 × 1

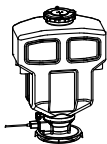

备用播撒盘 × 2

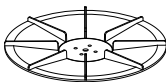

M4 × 12 螺丝 × 2



对于播撒系统 2.0，用户还可选购挡板及螺丝包配合使用。

## 部件名称

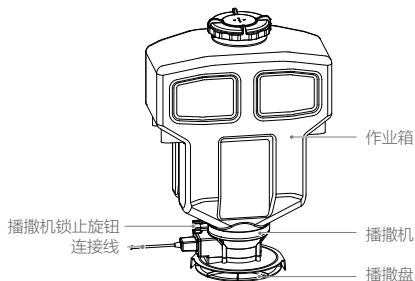

## 安装

安装前务必确保飞行器智能飞行电池已取下。安装时需自备适用于 M2.5、M3 和 M4 螺丝的六角扳手。

1. 向上提起并取出飞行器的喷洒作业箱。

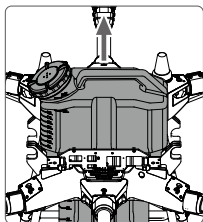

2. 移除飞行器前部上盖的所有胶塞及 5 颗 M3×8 螺丝，然后移除上盖。对于 T20 飞行器，还需取下左侧（面向机尾）的线卡保护盖。

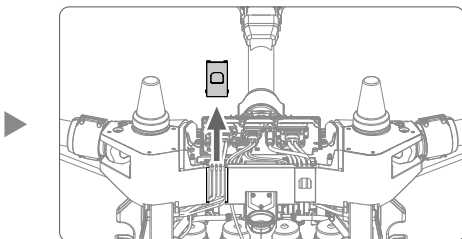
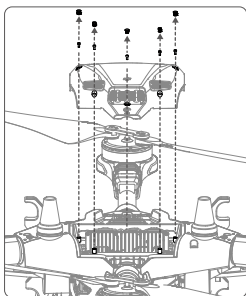

3. 在喷洒板上找到“流量计 / 液位计”接口，移除连接线接头上的 M2.5×8 螺丝，然后拔下连接线，放置于靠近机壳边缘的空位中。T20 与 T16 的喷洒板位置及结构不同，详见下图。

T20

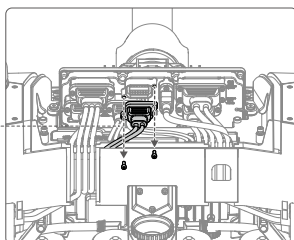
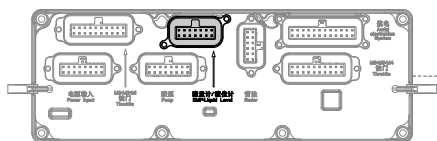

T16

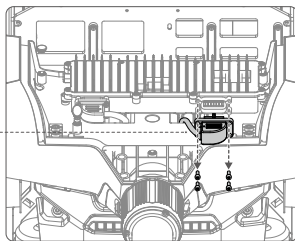
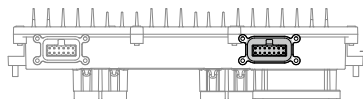

4. 分离播撒系统的作业箱与播撒机：向外拔出播撒机锁止旋钮，转动 90° 后松开以解除锁定，然后转动播撒机将其拆下。

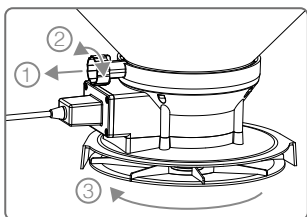

锁止状态

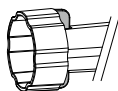

解锁状态

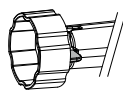

5. 对于播撒系统 2.0，用户可选择安装挡板至播撒机，安装挡板后播撒系统将不会向飞行器后方播撒物料。

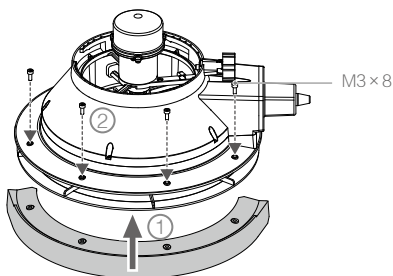

6. 连接播撒系统连接线：

T20

将播撒系统连接线从液泵与作业箱安装位的空隙穿过，嵌入飞行器左侧的线卡，然后插入“流量计/液位计”接口，并拧紧 2 颗 M2.5×8 螺丝。

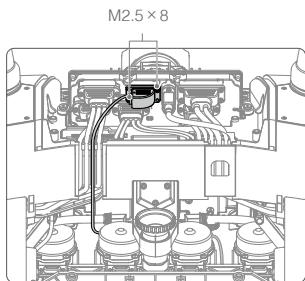

## T16

- 移除喷洒板两侧的 M3 × 8 螺丝，然后轻轻向上提起喷洒板，使其与安装位之间稍有空隙。注意不要扯到喷洒板上已连接的线材。
- 将播撒系统连接线从液泵与作业箱安装位的空隙以及喷洒板上方的空隙中依次穿过，然后插入“流量计/液位计”接口，并拧紧 4 颗 M2.5 × 8 螺丝。
- 重新安装喷洒板两侧的 M3 × 8 螺丝。

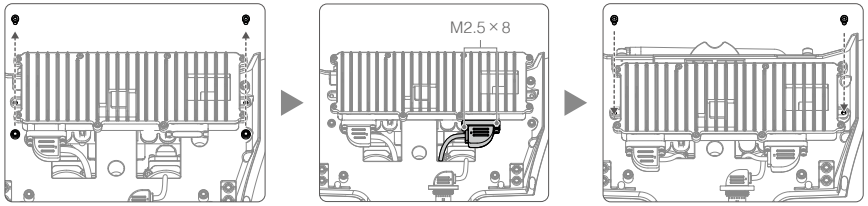

- 重新安装线卡保护盖（仅 T20）及飞行器上盖，拧紧 5 颗 M3 × 8 螺丝，装好所有胶塞。

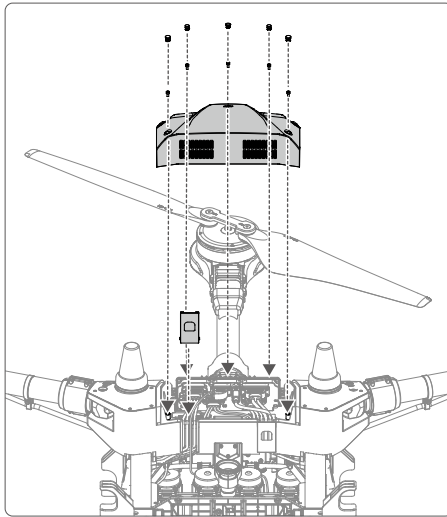

- 将播撒系统的作业箱插入飞行器，注意不要完全插入，作业箱中部与飞行器中框距离约 5 cm（如图）。

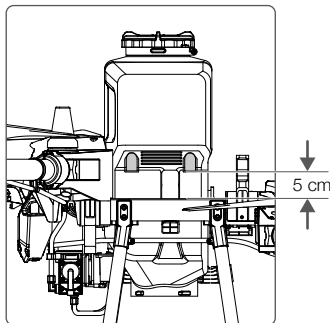

## 9. 安装播撒机:

- 面向飞行器尾部，确保播撒机锁止旋钮处于解锁状态，将旋钮位置偏向作业箱上圆形凹槽的左侧，然后向上嵌入播撒机。
- 转动播撒机将其安装至作业箱，然后向外拔出锁止旋钮，转动 90° 后松开以锁定播撒机。务必确保播撒机锁定到位。

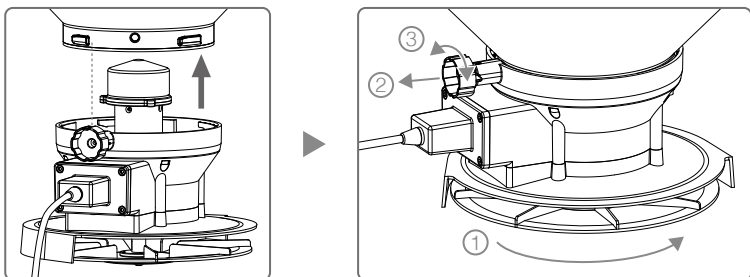

- 使用播撒系统连接线上的魔术贴将线材固定至起落架。

10. 将作业箱完全插入飞行器，确保安装到位，然后在作业箱后侧插入并拧紧 2 颗 M4 × 12 螺丝，将其固定。

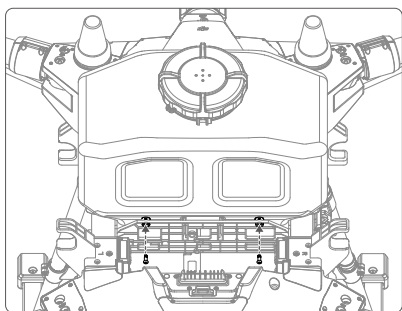

⚠ 务必小心操作，谨防机械结构伤手。

## 使用

1. 旋开作业箱盖子，加入适量物料，然后拧紧盖子。
2. 依次开启遥控器及飞行器。
3. 进入 App 作业界面。下文描述均以大疆农业 App 为例。
4. 点击屏幕左侧的仓口大小显示，进入播撒参数设置，可设置仓口大小、播撒盘转速、飞行速度、作业间距、相对作业高度、协调转弯等。不同作业模式下可设置的参数有所不同。用户需自行根据所使用的物料调整各参数并进行测试，以达到预期作业效果。

对于播撒系统 1.0，以物料亩用量 0.5 - 0.6 kg 为例，建议：

- 调节仓口大小使每分钟落料量为 1 kg；
- 调节播撒盘转速使播撒范围为 4 - 6 m；
- 设置飞行速度为 4 m/s（手动作业模式下飞行速度设置不生效）。

对于播撒系统 2.0，以物料亩用量 3 kg 为例，建议：

- 调节仓口大小使每分钟落料量为 8 kg；

- 调节播撒盘转速使播撒范围为 5 - 7 m；
- 设置飞行速度为 5 m/s（手动作业模式下飞行速度设置不生效）。

5. 按照飞行器使用方法进入所需作业模式进行播撒作业。播撒系统在不同作业模式下的运行方式略有不同。

### 航线作业模式

执行作业后，飞行器起飞上升至 4 米高度，同时播撒盘开始转动。飞行器飞至航线起点时，仓门按照所设值开启，飞行器沿航线飞行并播撒物料。用户不可手动开启或停止播撒。

作业时可使用作业恢复功能：作业暂停后，仓门关闭，播撒停止（播撒盘仍继续转动）；继续作业后，飞行器飞回中断坐标点或投影点，然后自动继续播撒作业。

### A-B 点作业模式

切换至 A-B 点作业模式后，播撒盘开始转动。飞行器飞至第一个节点时，仓门按照所设值开启，飞行器沿作业路线飞行并播撒物料。用户不可手动开启或停止播撒。

作业时可使用作业恢复功能：作业暂停后，仓门关闭，播撒停止（播撒盘仍继续转动）；继续作业后，飞行器飞回中断坐标点或投影点，然后自动继续播撒作业。

### 增强型手动作业模式

飞行器起飞后，切换至 M+ 作业模式。此时用户需短按一次遥控器喷洒按键（此时作为播撒按键使用）以使播撒盘转动。飞行器开始飞行后，仓门按照所设值开启，并自动播撒物料。

### 手动作业模式

飞行器起飞后，切换至 M 作业模式。用户可使用遥控器播撒按键手动开始或停止播撒。

 除手动作业模式外，其他作业模式下：

- 飞行器前后飞行时仓门自动开启，进行播撒；
- 飞行器左右飞行时仓门自动关闭，停止播撒（播撒盘仍继续转动）。

## 播撒系统校准

### 需要校准的情况

播撒系统出厂时已完成校准，可直接使用。若使用时出现以下情况，则用户需自行校准：

- 仓门无法完全打开或关闭；
- 落料速率与预期值有偏差；
- App 误报无料报警。

### 校准步骤

进入 App 作业界面 >  > ，在播撒系统设置中点击校准，然后等待校准完成。若校准失败，请重试。

## 维护保养

1. 定期清理作业箱及播撒机内的残渣。建议使用干燥的压缩空气吹气进行清理，并使用干净柔软的干布擦拭。切勿水洗。
2. 播撒盘为易损耗部件，如存在明显磨损，请按如下步骤及时更换播撒盘：
  - a. 确保飞行器电源断开，然后断开播撒系统连接线。
  - b. 拆下播撒机。
  - c. 移除播撒机下方的螺母、垫片、4 颗 M3×8 螺丝及播撒盘，然后安装新的播撒盘，装回垫片并拧紧 M3×8 螺丝及螺母。

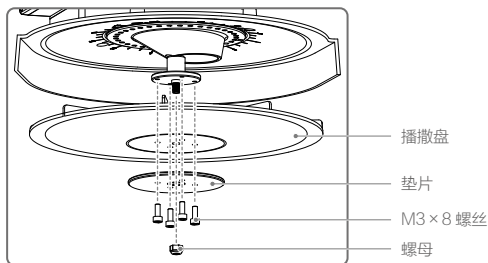

d. 重新安装播撒机至作业箱,并确保播撒机锁定到位。

⚠ 务必小心操作,谨防机械结构伤手。

## 规格参数

参数	播撒系统 1.0	播撒系统 2.0
适用飞行器 *	大疆 T16、T20 植保无人机	
播撒机重量	1.8 kg	2.1 kg (不含挡板)
最大仓门开口面积	8.6 cm <sup>2</sup>	32.3 cm <sup>2</sup>
适用物料颗粒直径	0.5 - 5 mm	
播撒作业箱容积	20 L	
播撒作业箱内部最大载重	配合 T16 使用时: 16 kg 配合 T20 使用时: 20 kg (注意: 日本版为 16 kg)	
播撒范围	与物料颗粒直径、播撒盘转速、仓口大小、飞行高度等因素有关。建议用户调整相关变量,使播撒范围处于 4 - 6 m(播撒系统 1.0)或 5 - 7 m(播撒系统 2.0),以获得较好的作业效果	

\* 需配合支持播撒系统的固件使用,请留意 DJI 官网对应机型的发布记录。

内容如有更新,恕不另行通知。

您可以在 DJI 官方网站查询最新版本  
<http://www.dji.com/t20>

DJI 和  是大疆创新的商标。

Copyright © 2020 大疆创新 版权所有

16 ©2020 大疆创新 版权所有







DJI Support  
DJI 技术支持

<http://www.dji.com/support>

If you have any questions about this document, please contact DJI by sending a message to [DocSupport@dji.com](mailto:DocSupport@dji.com).

如果您对说明书有任何疑问或建议，请通过以下电子邮箱联系我们：  
[DocSupport@dji.com](mailto:DocSupport@dji.com)。



Facebook



YouTube



微信扫一扫关注  
大疆农业服务公众号



微信扫一扫关注  
大疆行业应用公众号

