

AGRAS MG-1P SERIES

MG-1P / MG-1P RTK

User Manual V1.0

2018.11

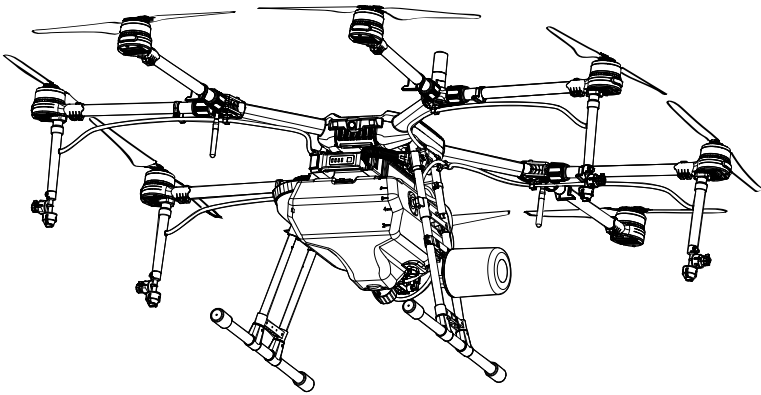

Searching for Keywords

Search for keywords such as “battery” and “install” to find a topic. If you are using Adobe Acrobat Reader to read this document, press Ctrl+F on Windows or Command+F on Mac to begin a search.

Navigating to a Topic

View a complete list of topics in the table of contents. Click on a topic to navigate to that section.

Printing this Document

This document supports high resolution printing.

Information

1. The AGRAS™ MG-1P / MG-1P RTK does not come with a flight battery. Please purchase the DJI™ Designated Battery (Model: MG-12000P). Read the battery's safety guidelines and take necessary precautions when handling to ensure your own safety. DJI assumes no liability for damage(s) or injuries incurred directly or indirectly from misusing batteries.
2. In this manual, the altitude limit of 30 meters (the altitude limit can be adjusted in the app) means the altitude between the aircraft and the surface of the objects below it when the altitude stabilization function of the radar module is enabled. If the function is disabled, the altitude limit means the altitude between the aircraft and the takeoff point.

Using This Manual

Legend

 Important

 Hints and tips

 Reference

Before Flight

The following manuals have been produced to help you get the most out of your AGRAS MG-1P / MG-1P RTK:

1. In the Box
2. Disclaimer and Safety Guidelines
3. Quick Start Guide
4. User Manual

Refer to In the Box to check the listed parts, and read the Disclaimer and Safety Guidelines before flight. Refer to the Quick Start Guide to complete assembly and to learn basic operation. Please refer to the User Manual for more comprehensive information.

Watch the Tutorial Videos

Please watch the tutorial videos at the link below, which demonstrates how to use the MG-1P / MG-1P RTK safely: <http://www.dji.com/mg-1p/info#video>



Download DJI Assistant 2 for MG

Download DJI ASSISTANT™ 2 for MG from:
<http://www.dji.com/mg-1p/info#downloads>

Safety at a Glance

1. Pesticide Usage

- Avoid the use of powder pesticides as much as possible or else they may reduce the service life of the spraying system.
- Pesticides are poisonous and pose serious risks to human safety. Please use them in strict accordance with their specifications.
- Residue on the equipment caused by splashes or spills when pouring and mixing the pesticide can irritate your skin. Be sure to clean the equipment after mixing.
- Use clean water to mix the pesticide to avoid blocking the strainer. Clear any blockages before using the equipment.
- Wear protective clothing to prevent direct body contact with the pesticide. Always rinse your hands and skin after handling pesticides. Clean the aircraft and remote controller after applying the pesticide.
- Effective use of pesticides relies on pesticide density, spray rate, spray distance, aircraft speed, wind speed and wind direction. Consider all factors when using pesticides, but NEVER compromise the safety of people, animals and the environment in doing so.
- DO NOT contaminate rivers and sources of drinking water.



The Agras MG-1P / Agras MG-1P RTK (abbreviated as "MG-1P" / "MG-1P RTK") aircraft is NOT a toy and is not suitable for children under the age of 18.

Note that 'Safety at a Glance' only provides a quick overview of the safety tips. Make sure you read and understand the remaining sections of this document and the User Manual.

2. Environmental Considerations

- Always fly at locations that are clear of building and other obstacles.
- DO NOT fly above or near large crowds.
- Avoid flying at altitudes above 98 feet (30 m).
- Be very careful when flying over 6,560 feet (2,000 m) above sea level.
- Fly in moderate weather conditions with temperatures between 32° to 104° F (0° to 40° C).
- Ensure that your operations do not violate any applicable laws or regulations, and that you have obtained all appropriate prior authorizations. Consult the relevant government agency or authority, or your lawyer before flight to ensure you comply with all relevant laws and regulations.
- DO NOT operate any parts of the aircraft indoors.

3. Pre-flight Checklist

- Remote controller and aircraft batteries are fully charged.
- Landing gear and spray tank are firmly in place.
- All screws are firmly tightened.
- Propellers and frame arms are unfolded, and arm sleeves are firmly tightened.
- Propellers are in good condition and firmly tightened.
- There is nothing obstructing the motors.

- Spraying system is without any blockage and works properly.
- Compass is calibrated at every new flight location.

4. Operation

- Stay away from the rotating propellers and motors.
- The takeoff weight must not exceed 24.8 kg (taking off at sea level).
- Maintain a visual line of sight (VLOS) to your aircraft at all times.
- DO NOT use the Combination Stick Command (CSC) or other methods to stop the motors when the aircraft is airborne unless in an emergency situation.
- DO NOT answer incoming calls during flight.
- DO NOT fly under the influence of alcohol or drugs.
- During the Return to Home procedure, if the operating environment is not suitable for the radar module to work properly, the aircraft will not be able to avoid obstacles. You can adjust the flight speed and altitude to avoid obstacles if the remote controller is connected to the aircraft.
- In the instance of a Low Battery Warning, land the aircraft at a safe location.
- After landing, first stop the motors, then power off the aircraft, and then turn off the remote controller. Otherwise, the aircraft may enter Failsafe RTH automatically due to remote controller signal loss.
- Please maintain full control of the aircraft at all times and do not rely on the DJI MG app. The obstacle avoidance function is disabled in certain situations. Please keep the aircraft within your visual line of sight and visually observe the flight. Please use your sound discretion to operate the aircraft and avoid obstacles timely and manually. It is important to set an appropriate Failsafe and Return to Home altitude before each flight.

5. Maintenance and Upkeep

- DO NOT use aged, chipped or broken propellers.
- Remove or empty the spray tank during transportation or when not in use to avoid damaging the landing gear.
- Recommended storage temperature (empty spray tank): between -4° and 104° F (-20° and 40° C).
- Clean the aircraft immediately after spraying.
- Inspect the aircraft every 100 flights or after flying for over 20 hours.
- For more maintenance guidelines, refer to the Product Care section in this document.

6. Observe Local Laws and Regulations

- You can find a list of DJI GEO Zones at <http://www.dji.com/flysafe>.
- The DJI GEO Zones is not a replacement for local government regulations or good judgment.
- Avoid flying in areas where rescue teams are actively using the airspace.



Fly in Open Areas

+



Calibrate the
Compass

+

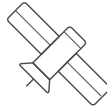

Strong GNSS Signal

+



VLOS

+



Fly Below
98 feet (30 m)

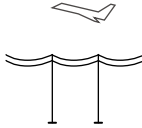

Avoid flying over or near crowds, high voltage power lines or bodies of water.

Strong electromagnetic sources such as power lines, base stations, and tall buildings may affect the onboard compass. It is recommended to use MG-1P RTK. Always stay alert about surroundings in flight.



DO NOT use the aircraft in adverse weather conditions such as rain (precipitation rate exceeding 25 mm or 0.98 inches in 12 hours), wind speeds exceeding 8 m/s or 17 mph (28 kph), fog, snow, and lightning.

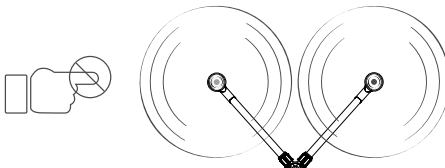

Stay away from the rotating
propellers and motors.



GEO Zones

Learn more at:
<https://www.dji.com/flysafe>

Contents

Information	1
Using This Manual	1
Legend	1
Before Flight	1
Watch the Tutorial Videos	1
Download DJI Assistant 2 for MG	1
Safety at a Glance	2
Product Profile	7
Introduction	7
Feature Highlights	7
Overview	8
Installation	11
Mounting the Landing Gear	11
Mounting the Power Port Module	12
Mounting the Spray Tank	12
Unfolding the Frame Arms	13
Mounting the Sprinklers	14
Mounting the Radar Module	15
Mounting the Remote Controller Battery	16
Mounting the Flight Battery	16
Mounting the Dongle	17
Remote Controller	17
Profile	17
Using the Remote Controller	18
Remote Controller LEDs	23
Multi-Aircraft Control Function	24
Linking the Remote Controller	24
DJI MG App	26
Main Screen	26
Operation View	27

Aircraft	30
Profile	30
Flight Modes	30
Operation Modes	30
Operation Resumption	36
System Data Protection	38
Radar Module	38
Empty Tank	40
Return to Home (RTH)	40
Low Battery Warnings	43
RTK Functions (for MG-1P RTK only)	43
Flight	44
Operation Environment	44
Flight Limits and No-Fly Zones	44
Pre-Flight Checklist	46
Calibrating the Compass	46
Calibrating the Spraying System	47
Starting and Stopping the Motors	48
Flight Test	49
DJI Assistant 2 for MG	50
Installation and Launching	50
Using DJI Assistant 2 for MG	50
Appendix	51
Specifications	51
Aircraft Status Indicators Description	54
Updating the Firmware	54

Product Profile

Introduction

The Agras MG-1P series (MG-1P / MG-1P RTK) aircraft are equipped with a wide-angle First Person View (FPV) camera which enables observation of the landscape in front of the aircraft, allowing operation areas to be identified and enabling pilots to avoid obstacles. Its second generation high-precision radar with integrated obstacle avoidance radar module and forward, backward, and downward altitude stabilization radar modules provides improved obstacle sensing and terrain following capabilities. The quality of the aircraft's industrial design and materials make it dust-proof, water-proof (IP43 protection rating, IEC standard 60529), and corrosion-resistant. The MG-1P and MG-1P RTK utilize DJI's dedicated A3 flight control system with eight-rotor propulsion redundancy, ensuring safe and stable operation at all times. The MG-1P RTK has a built-in DJI Onboard D-RTK™, which provides more accurate data for centimeter-level positioning*.

The remote controller uses the DJI OCUSYNC™ dual-band video downlink system, has a maximum control distance of up to 3.11 mi (5 km)*, and is equipped with a bright, dedicated screen with the DJI MG app built-in. Operation planning can be performed either using the remote controller only or by flying the aircraft to waypoints. The Banked Turning feature in the DJI MG app commands the aircraft to take corners without fully stopping, making flight operations more flexible and efficient. The remote controller's Multi-Aircraft Control mode can be used to coordinate the operation of up to five aircraft at the same time, enabling pilots to work very efficiently. Replaceable batteries make it easy to use the remote controller every day and removable antennas make maintenance easier.

Feature Highlights

The MG-1P / MG-1P RTK uses a DJI dedicated flight control system, providing four operation modes: Route, A-B Route, Manual, and Manual Plus.

The DJI MG app automatically produces flight routes based on your planned fields. Plan a field by walking with the remote controller or by flying the aircraft to waypoints. To start, simply select the field from the field list.

In A-B Route operation mode, the aircraft will travel along a pre-planned route and spray its liquid payload. Users can set the line spacing, flying speed, and other parameters.

In Manual operation mode, users can start and stop spraying manually and also adjust the spray rate.

In Manual Plus operation mode, flight speed is restricted and heading is locked. Except for the heading, users can control the aircraft's movement via control sticks. Press button C1/C2 on the remote controller or the corresponding button in the app and the aircraft will fly one line spacing to the left/right. (This is the default function for button C1 and button C2. They are customizable in the app.)

The MG-1P / MG-1P RTK also includes the Operation Resumption function. When pausing the operation in Route or A-B Route operation mode, Operation Resumption records a breakpoint for the aircraft. Users can resume from the return point when continuing the operation.

* This should be used with a DJI approved Network RTK service or a DJI D-RTK 2 GNSS High-Precision Mobile Station (sold separately). Refer to RTK Functions (p. 43) for details.

The remote controller is able to reach its maximum transmission distance (FCC: 3.11 mi (5 km); CE / KCC / MIC / SRRC: 1.86 mi (3 km)) in a wide open area with no electromagnetic interference, and at an altitude of about 8.2 ft (2.5 m).

The remote controller features Multi-Aircraft Control mode, which can be used to coordinate the operation of up to five aircraft simultaneously. Turn the Aircraft Control Switch Dial on the remote controller to switch control between the different aircraft.

The second generation high-precision radar mode works automatically in Route, A-B Route, and Manual Plus operation mode. Altitude detection and stabilization functions are available in forward, backward, and downward directions while the obstacle avoidance function is available in forward or backward direction according to the direction of flight.

The spraying system includes a spray tank, liquid level meter, sprinklers, and other accessories. The four sprinklers placed on the aircraft's two sides provide evenly distributed spraying and coverage of the liquid payload. Optimized structures and algorithms of the spraying system for more precise spraying control and more effective leak and drip prevention.

The MG-1P RTK has a built-in DJI Onboard D-RTK, providing more accurate data for centimeter-level positioning when used with the DJI D-RTK 2 or Network RTK Service. An optional Handheld RTK or PC GS Pro is available for more precise field planning, enhancing the accuracy of agricultural operations.

Overview

Aircraft

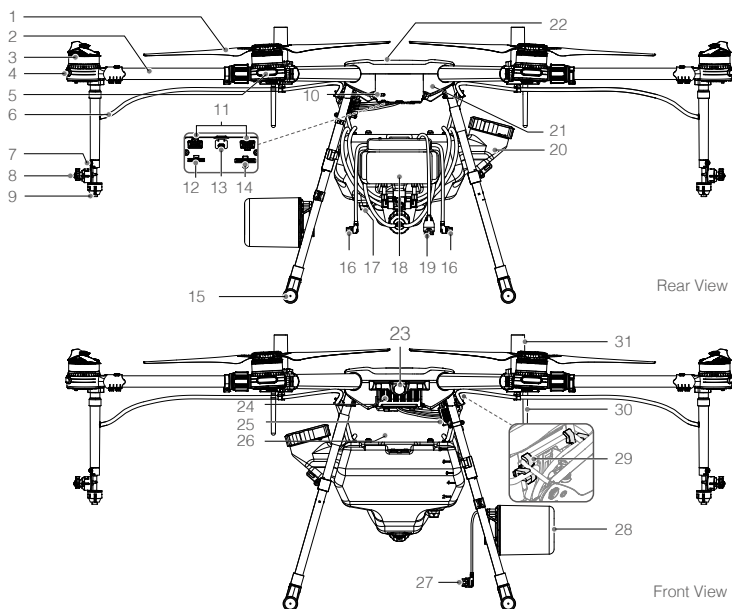

- | | | |
|---|-----------------------------|--|
| 1 Propellers | 11 Pump Ports | 23 FPV Camera |
| 2 Frame Arms | 12 Radar Port | 24 Intake Vent |
| 3 Motors | 13 Micro USB Port | 25 Power Port |
| 4 ESC LEDs
(on M1-M4 and M7-M8 arms) | 14 Liquid Level Meter Port | 26 Battery Compartment |
| 5 Aircraft Status Indicators
(on M5-M6 arms) | 15 Landing Gear | 27 Radar Cable |
| 6 Hoses | 16 Pump Cables | 28 Radar Module |
| 7 Sprinklers | 17 Liquid Level Meter | 29 Remote Controller Holder |
| 8 Manual Relief Valve | 18 Delivery Pumps | 30 OCUSYNCTM Dual-band
Antennas |
| 9 Nozzles | 19 Liquid Level Meter Cable | 31 Onboard D-RTK Antennas
(on MG-1P RTK only) |
| 10 Link Button | 20 Spray Tank | |
| | 21 Aircraft Body | |
| | 22 GNSS Module | |

- ⚠** • DO NOT obstruct the GNSS module (located at the center of the aircraft), as doing so would reduce the GNSS signal strength.
- The MG-1P and MG-1P RTK do not come with a battery. Please purchase the DJI approved battery pack (Model: MG-12000P).

Remote Controller

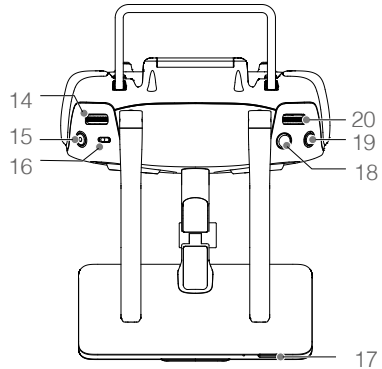
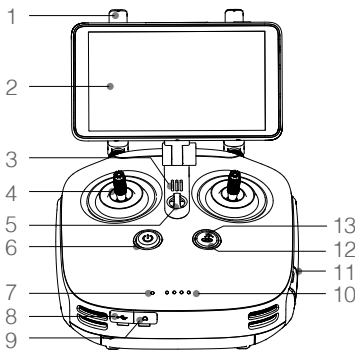

- | | |
|---|---|
| <p>1 Antennas
Relays aircraft control signals.</p> <p>2 Display Device
Android-based to run the DJI MG app.</p> <p>3 Speaker
Audio output.</p> <p>4 Control Sticks
Controls aircraft movement. Can be set to Mode 1, Mode 2, or a custom mode.</p> <p>5 Lanyard Attachment
Used to attach the remote controller lanyard.</p> | <p>6 Power Button
Used to turn the remote controller on and off.</p> <p>7 Status LED
Indicates whether the remote controller is linked to the aircraft.</p> <p>8 USB-C Port
Connects to a computer via a USB-C cable for configuration. Connects to the aircraft via a USB-C OTG cable and a Micro USB cable for aircraft firmware update.</p> |
|---|---|

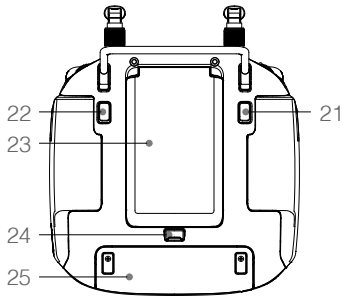

9 3.5 mm Audio Jack

Used to connect an audio input/output device.

10 Battery Level LEDs

Displays current battery level.

11 MicroSD Card Slot

Provides display device with up to 128 GB of extra storage.

12 RTH Status LED

Circular LED around the RTH button. Displays RTH status.

13 RTH Button

Press and hold this button to initiate Return to Home (RTH).

14 Spray Rate Dial

Turn to adjust the spray rate in Manual operation modes.

15 Spray Button

Press to start/stop spraying in Manual operation mode.

16 Pause Switch

Toggle to pause the operation in Route, A-B Route or Manual Plus operation modes. During RTH, toggle to pause RTH. The aircraft hovers, and then the aircraft can be controlled manually.

17 Sleep/Wake Button

Press to sleep/wake the screen; press and hold to restart.

18 Button A

Records Point A of the operation route in A-B Route operations by default. Use the app to customize the button.

19 Button B

Records Point B of the operation route in A-B Route operations by default. Use the app to customize the button.

20 Aircraft Control Switch Dial

Turn and press the dial to switch among the aircraft when using Multi-Aircraft Control function.

21 Button C1

When you are planning a field, it starts or ends obstacle measurement. When planning a field, the function cannot be customized. When you are not planning a field, the default function is Map/FPV Switch. Use the app to customize the button.

22 Button C2

When you are planning a field, it adds a waypoint. When planning a field, the function cannot be customized. When you are not planning a field, then the default function is Delete Route. Use the app to customize the button.

23 Battery Compartment Cover

Open the cover to mount or remove the Intelligent Battery from the remote controller.

24 Battery Compartment Cover Lock

Slide the lock down to open the cover.

25 Dongle Compartment Cover

Open the cover to mount or remove the dongle.

Installation

- ⚠ • Threadlocker of medium strength is required for installation. Apply threadlocker when mounting the landing gear, power port module, spray tank, sprinklers, and radar module. Ensure the threadlocker is totally dry and solid before flight.
- DO NOT bend the hoses in an arc tighter than their minimum bend radius during installation. This is to avoid creasing, which may compromise the spraying effect.
- Ensure that all installation and connection procedures are completed before powering on the aircraft.

The installation steps are the same for both the MG-1P and MG-1P RTK. In the figures below the MG-1P is shown.

Mounting the Landing Gear

1. Identify the landing gear leg containing the compass cable.
2. Take out the compass cable from the tube of the landing gear leg and connect it to the compass port on the aircraft's right side, then mount the right landing gear leg to the mounting position. Be careful not to damage the cable.
3. Secure the right landing gear leg in place using four M3×10 screws.

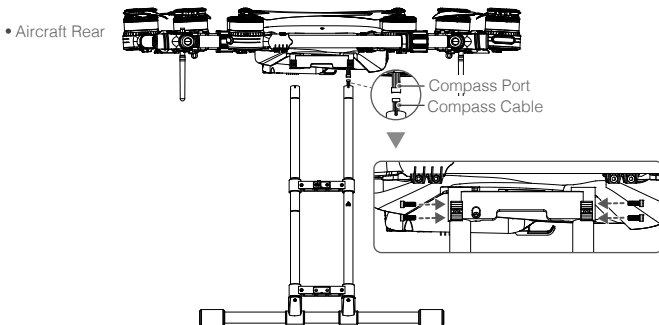

4. Mount the left landing gear leg and secure it in place using three M3×10 screws.

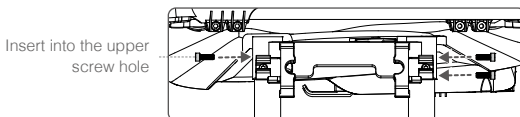

Mounting the Power Port Module

Mount the power port module onto the left landing gear leg using two M3x18 screws and one M3x22 screw.

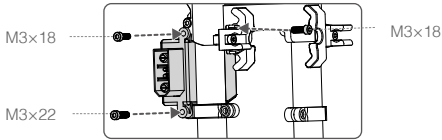

Mounting the Spray Tank

1. Connect the sprinkler kits to the spray tank: Pull the four hoses through the nuts to the outlets under the delivery pump, then tighten the nuts using a wrench. Note that the white and black hoses should be attached to outlets with labels of the same color. Be sure to securely tighten the nuts to avoid liquid leakage.

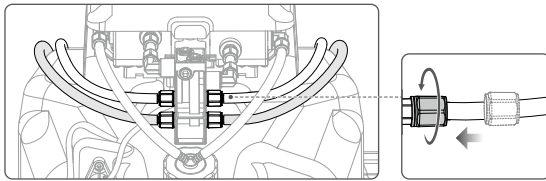

2. Remove the cover of the spray tank. Pull the hoses on both sides through the spaces between the two tubes of each landing gear leg with the mouth of the tank facing toward the right side of the aircraft.
3. Lift the spray tank and pull the mouth of the tank through the space between the two tubes of the right landing gear leg.

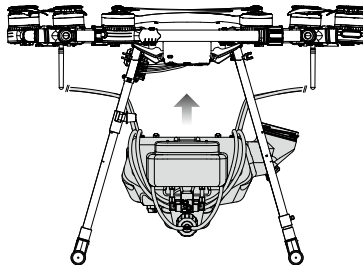

4. Insert the plugs on the left landing gear leg into the mounting holes on the spray tank.
5. Slide the fixing bracket on the right landing gear leg to the marks on the tubes to align the screw holes on the fixing bracket with the fin on the right side of the spray tank. Tighten the two M3×12 screws and insert and tighten one M3×10 (Plus) screw.

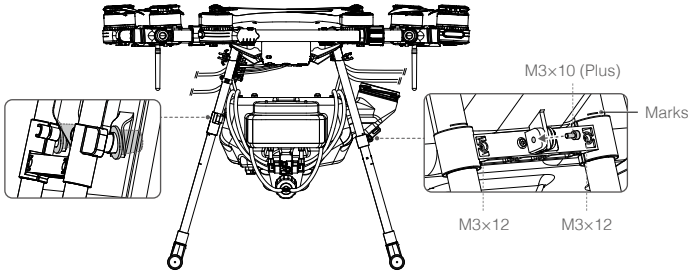

6. Connect the two pump cables and one liquid level meter cable to their corresponding ports on the aircraft body.

Unfolding the Frame Arms

1. Unfold the frame arms ① and tighten the two arm sleeves at each of the junctions ②.
2. Identify the position and rotational direction of the motors. The top view shows motors M1 to M8 arranged in a counter-clockwise order, with motors M1 and M2 at the front of the aircraft, and motors M5 and M6 at the rear. Motors M1, M3, M5, and M7 rotate counter-clockwise as indicated by the "CCW" mark, while motors M2, M4, M6, and M8 rotate clockwise as indicated by the "CW" mark.

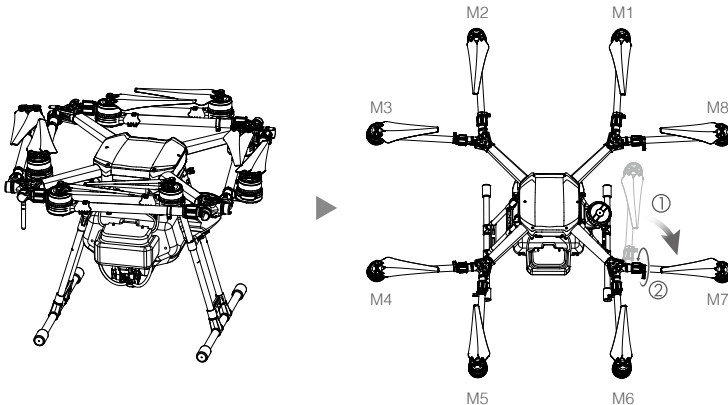

Mounting the Sprinklers

1. Mount the hose clips: Mount one hose clip to the bottom of each of the four frame arm junctions using T3x10 screws. Mount one hose clip to the outside of the right landing gear leg mounting position using an M3x6 screw.

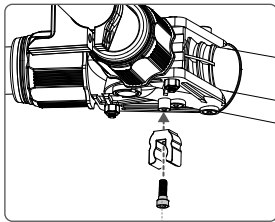

T3x10

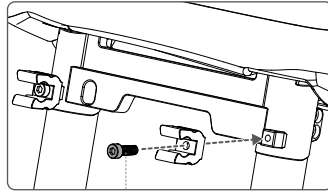

M3x6

2. Mount the sprinklers with white hoses under motors M3 and M8 (with white circle marks). Mount the sprinklers with black hoses under motors M4 and M7 (with black circle marks). Mount each of the four sprinklers using three M3x8 (Plus) screws, then insert the hoses into the clips at the bottom of the frame arm junctions. Be sure to mount the sprinklers to the mounting holes nearer to the inside of the aircraft, with the hoses facing the frame arm.

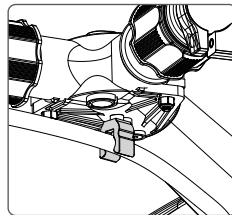
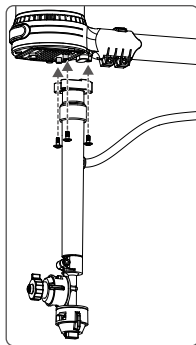

3. Insert the hoses on both sides into the clips on the landing gear.

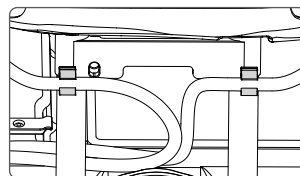
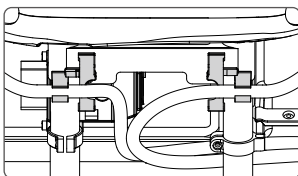

4. Mount the fender to the right landing gear leg to avoid spills when pouring liquids. Handle with care to avoid damage to the fender.

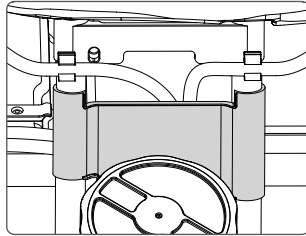

Mounting the Radar Module

1. Mount the radar bracket to the radar module using four M3×5.5 screws, with the bracket crossbar over the radar cable as shown in the figure below.

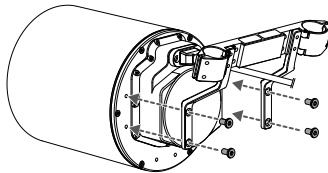

2. Unfasten the buckles on the bracket then mount it to the left landing gear leg. Align the bracket to the lower marks on the landing gear leg. Fasten the buckles and secure them using four M3×5.5 screws.

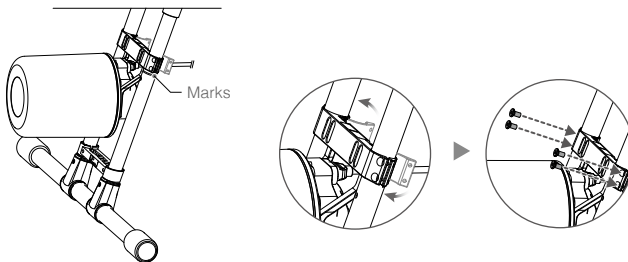

3. Insert the radar cable into the cable clip on the landing gear leg, then connect it to the radar port on the aircraft body.

Mounting the Flight Battery

Insert the battery into the battery compartment from the front of the aircraft. Ensure the battery is securely mounted and then fasten the belt to the stud on the spray tank.

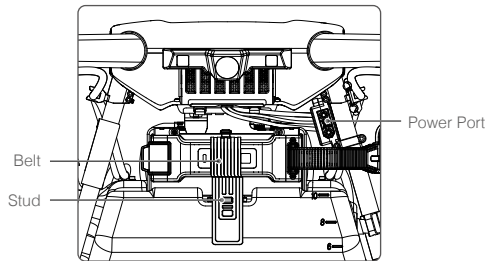

- ⚠ The MG-1P and MG-1P RTK do not come with a battery. Please purchase the DJI approved MG-1P battery pack (Model: MG-12000P).
- The voltage on the aircraft can reach 50.4 V. Read the battery's safety guidelines and take necessary precautions when handling the battery to ensure your own safety.

Mounting the Remote Controller Battery

The remote controller uses a removable, interchangeable Intelligent Battery making long-term operation easy.

Slide the battery compartment cover lock on the back of the remote controller down to open the cover ①, insert the Intelligent Battery into the compartment and push it to the top ②, then close the cover ③.

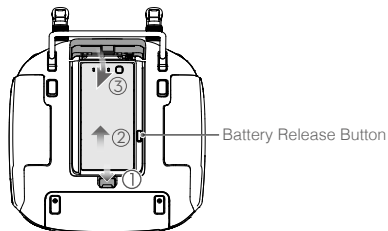



- 💡 To remove the Intelligent Battery, open the cover, press and hold the battery release button, then push the battery downward.

Mounting the Dongle

- ⚠ • Only use a DJI approved dongle.
- The dongle supports various network standards. Use a SIM card that is compatible with the chosen mobile network provider and select a mobile data plan according to the planned level of usage.
- Use the dongle and the SIM card in accordance with their manuals.
- The dongle and SIM card are used to enable the remote controller to access to specific networks and platforms, such as the DJI Agriculture Management Platform. Be sure to mount them correctly, or else network access will not be available.

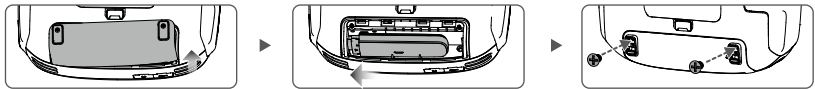
1. Lift the dongle compartment cover at the gap at its lower right corner, then remove it.
2. Insert the SIM card into the dongle and then insert the dongle into the USB port inside the compartment. Test to ensure that they function properly.*
3. Cut the connecting string between the dongle cap and dongle body if there is one.
4. Re-mount the dongle compartment cover. To secure the cover, open the silicone protectors on the cover, insert and tighten two M1.6x3 screws, then close the silicone protectors.



* Test procedure: Press the remote controller power button once, then press again and hold to turn the remote controller on. In the DJI MG app tap  and select Network Diagnostics. If the statuses of all the devices in the network chain are shown in green the dongle and SIM card are functioning properly.

Remote Controller

Profile

The remote controller uses the DJI OcuSync dual-band video downlink system, has a maximum control distance of up to 3.11 mi (5 km). It includes a dedicated, Android-based display that runs the DJI MG app independently for operation planning and aircraft status display. Its Multi-Aircraft Control mode can be used to coordinate the operation of up to five aircraft at the same time to improve operation efficiency.

 Stick mode can be set to Mode 1, Mode 2, and Mode 3, or to a custom mode in the DJI MG app. It is recommended to set it to Mode 2 for beginners.

Mode 1: The right stick serves as the throttle.

Mode 2: The left stick serves as the throttle.

Using the Remote Controller

Turning the Remote Controller On and Off

The remote controller uses a removable, interchangeable Intelligent Battery. The battery level is indicated via the Battery Level LEDs on the front panel after the battery is mounted. Follow the steps below to turn on your remote controller:

1. When the remote controller is turned off, press the Power button once to check the current battery level, indicated by the Battery Level LEDs. If the battery level is too low, recharge before use.
2. Press the Power button once. Then press and hold to turn on the remote controller.
3. The remote controller will beep when turned on. The Status LED will rapidly blink green, indicating that the remote controller is linking to the aircraft. They will glow solid green when linking is complete.
4. Repeat Step 2 to turn off the remote controller.

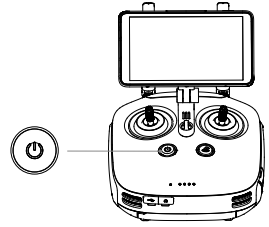

 The remote controller internal backup battery allows users to insert and remove the external Intelligent Battery while the remote controller is still on and in use. The device will enter Sleep Mode to save power. Users are then required to replace the Intelligent Battery within three minutes, or the remote controller will power off.

Charging the Remote Controller

Charge the remote controller Intelligent Battery using the included AC power adapter and Charging Hub.

1. Place the battery into the Charging Hub, connect the AC power adapter to the Charging Hub, and then connect the charger to a power outlet (100-240V, 50/60Hz).
2. The Charging Hub will intelligently charge batteries in sequence according to battery power levels from high to low.
3. The Status LED blinks green when charging and turns solid green when fully charged. The buzzer will begin beeping when charging is complete. Remove the battery or turn off the buzzer to stop it.

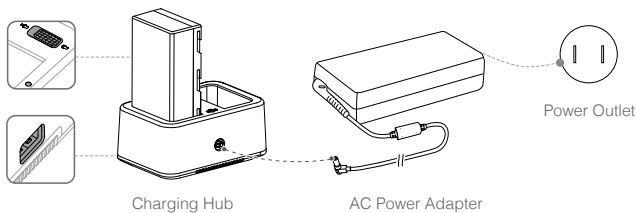

Operating the Aircraft

This section explains how to control the orientation of the aircraft through the remote controller. Control can be set to Mode 1, Mode 2 or Mode 3, or to a custom mode.

Mode 1

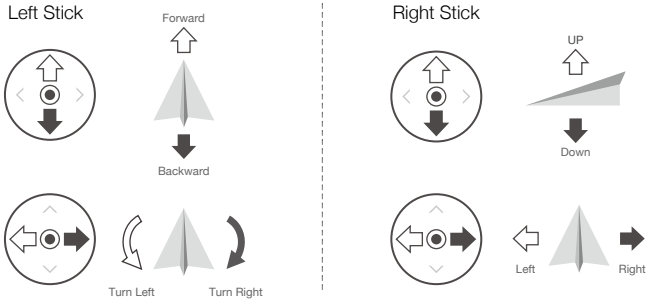



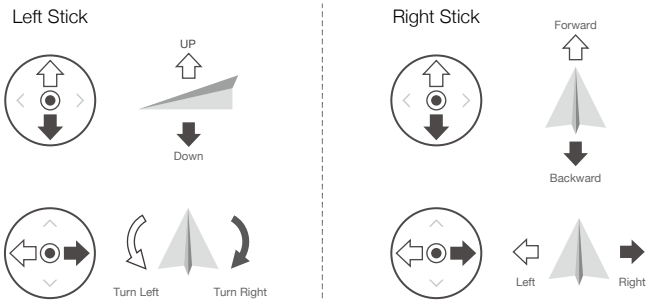

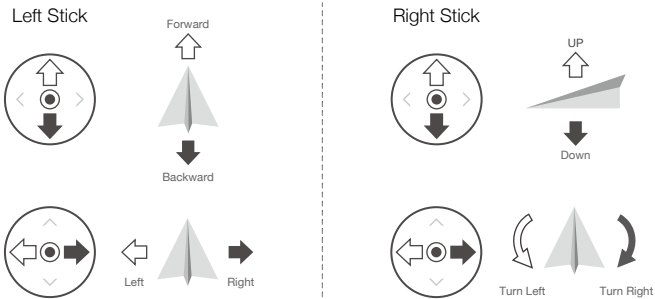

Mode 2

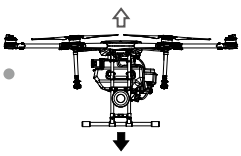

Mode 3

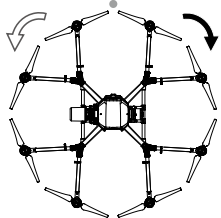

For example, the following description uses Mode 2:

Remote Controller (Mode 2)	Aircraft (● Indicates nose direction)	Remarks
		<p>Throttle Stick: Vertical movement of the left stick controls the aircraft's elevation. Push up to ascend and push down to descend. Use the left stick to take off when the motors are spinning at idle speed. The aircraft will hover in place if the stick is in the center position. The farther the stick is pushed away from the center position, the faster the aircraft will change elevation.</p>
		<p>Yaw Stick: Horizontal movement of the left stick controls the aircraft's heading. Push left to rotate the aircraft counterclockwise and push right to rotate clockwise. The aircraft will hover in place if the stick is in the center position. The farther the stick is pushed away from the center position, the faster the aircraft will rotate.</p>
		<p>Pitch Stick: Vertical movement of the right stick controls the aircraft's pitch. Push up to fly forwards and press down to fly backwards. The aircraft will hover in place if the stick is in the center position. Push the stick farther for a larger pitch angle and faster flight.</p>
		<p>Roll Stick: Horizontal movement of the right stick controls the aircraft's roll. Push the stick left to fly left and right to fly right. The aircraft will hover in place if the stick is in the central position. Push the stick farther for a larger roll angle and faster flight.</p>

Controlling the Spraying System

Complete an operation remotely via the Spray Rate or Aircraft Control Switch dials, or the Spray, A/B, and C1/C2 buttons.

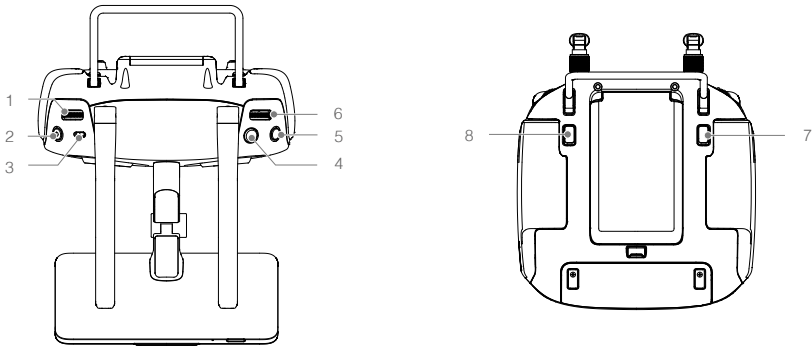

1 Spray Rate Dial

In Manual or Manual Plus operation mode, turn left to reduce and right to increase the spray rate*. The DJI MG app will indicate the current spray rate.

* Spray rate may vary according to the nozzle model and viscosity of the liquid.

2 Spray Button

In Manual operation mode, press to start or stop spraying.

3 Pause Switch

Toggle to pause the operation in Route or A-B Route operation modes. The aircraft hovers and records the breakpoint, and then the aircraft can be controlled manually. To resume a Route operation, select the operation in the app. To resume an A-B Route operation, tap Resume on the screen. Then the aircraft returns to the breakpoint automatically and continues the operation.

During RTH, toggle to pause RTH. The aircraft hovers, and then the aircraft can be controlled manually.

4 Button A

Records Point A of the operation route in A-B Route operations by default. Use the app to customize the button.

5 Button B

Records Point B of the operation route in A-B Route operations by default. Use the app to customize the button.

6 Aircraft Control Switch Dial

Turn and press the dial to switch among the aircraft when using Multi-Aircraft Control function.

7 Button C1

When you are planning a field, it starts or ends obstacle measurement. When planning a field, the function cannot be customized. When you are not planning a field, the default function is Map/FPV Switch. Use the app to customize the button.

8 Button C2

When you are planning a field, it adds a waypoint. When planning a field, the function cannot be customized. When you are not planning a field, then the default function is Delete Route. Use the app to customize the button.

The table below is a summary for how to control the spraying system via the remote controller in different modes.

Mode	Spray Rate Dial	Spray Button	Pause Switch	Button A	Button B	Aircraft Control Switch Dial	Button C1	Button C2
Route operation mode	/	/	Pause	Customizable	Customizable	Switch between aircraft	Customizable	Customizable
A-B Route operation mode	/	/	Pause	Customizable	Customizable	/	Customizable	Customizable
Manual operation mode	Adjust spray rate	Start or stop spraying	/	Customizable	Customizable	/	Customizable	Customizable
Manual Plus operation mode	Adjust maximum spray rate	/	/	Customizable	Customizable	/	Customizable	Customizable
Field Plan	/	/	/	/	/	/	Start or end obstacle measurement	Add a waypoint

RTH Button

Press and hold the RTH button to bring the aircraft back to the last recorded Home Point. The LED around the RTH Button will blink white during RTH procedure. Users can control aircraft heading while it flies to the Home Point. Press this button again to cancel RTH and regain control of the aircraft.

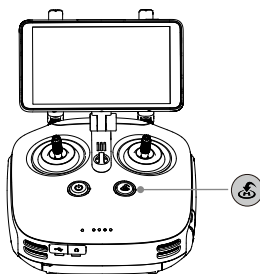

Optimal Transmission Zone

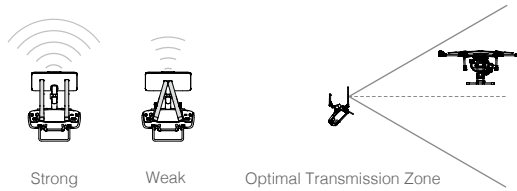

Try to keep the aircraft inside the optimal transmission zone. If the signal is weak, adjust the antennas or fly the aircraft closer.

Remote Controller LEDs

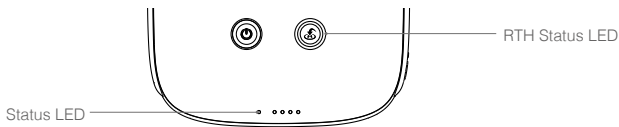

The Status LED indicates the connection status between the remote controller and the aircraft. The RTH Status LED indicates the Return to Home status of the aircraft. See the table below for details on these indicators:

Status LED	Sound	Remote Controller Status
— Solid Red	🎵 chime	The remote controller is not connected to the aircraft.
— Solid Green	🎵 chime	The remote controller is connected to the aircraft.
..... Blinks Red	Repeating slow beep	Remote controller error.
RTH Status LED	Sound	Aircraft Status
— Solid White	🎵 chime	Return to Home procedure is initiated.
..... Blinking white	Repeating single beep	Sending Return to Home command to the aircraft.
..... Blinking white	Repeating double beep	The aircraft is returning to the Home Point.

Linking the Remote Controller

The remote controller is linked to your aircraft by default. Linking is only required when using a new remote controller for the first time. If using Multi-Aircraft Control function, linking all the aircraft to the same remote controller is required.

1. Power on the remote controller and open the DJI MG app. Power on the aircraft.
2. Tap Perform an Operation to enter Operation View and tap ●●● > 🛩️. Select Aircraft as the linking device, tap Single Linking or Multi Linking (if Multi-Aircraft Control is in use), and then tap Starting Linking. The Status LED blinks blue and the remote controller sounds double beep repeatedly, indicating that the remote controller is ready for linking.

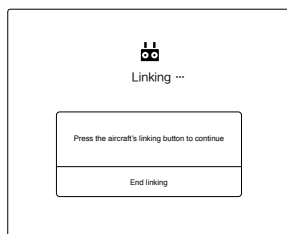

3. Press the Link button on the aircraft. Then release and wait for a few seconds.
4. The Status LED and Link LED will glow solid green if linking is successful. If the Link LED does not glow solid green, linking failure occurred. Enter linking status again and retry.
5. Repeat steps 3 and 4 to complete linking between all the aircraft (up to five) and the remote controller, if Multi Linking is selected. Then tap End linking.

Multi-Aircraft Control Function

The remote controller features Multi-Aircraft Control function which can be used to coordinate the operation of up to five aircraft at the same time, enabling pilots to work very efficiently. It is recommended for large spray areas. Turn the Aircraft Control Switch Dial on the remote controller to switch between different aircraft for single control of the desired aircraft.

- The Multi-Aircraft Control function can only be used in Route operation mode in the current period. Ensure to complete field planning and related configurations before entering Multi-Aircraft Control mode, since operations of other modes cannot be used except Route operations.
- When using the Multi-Aircraft Control function, to avoid interference among operation groups, do not operate more than three groups within a 50-meter radius. Unless using the MG-1P RTK with a DJI D-RTK 2 Mobile Station, it is necessary to manually configure each remote controller's serial number in the DJI MG app.

Enter Multi-Aircraft Control Mode

1. Link all the aircraft (up to five) to the same remote controller according to the steps in "Linking the Remote Controller".

2. Close the settings menu after linking. The linked aircraft will be listed on the left of the screen sorted by number.

Switch Control

Users can switch control among different aircraft via the aircraft status box on the left screen in the app or the Aircraft Control Switch Dial on the remote controller.





Switch in the App

Tap the status box of the corresponding number in the app. The side of the box will turn blue and the ESC LEDs of the aircraft will blink red quickly, indicating the corresponding aircraft has been selected.

Switch by the Dial

1. Turn the Aircraft Control Switch Dial on the remote controller. There will be an arrow near the corresponding status box in the app, and the ESC LEDs of the aircraft will blink yellow quickly, indicating the corresponding aircraft is in pre-selected status.
2. Press the dial once. The side of the box in the app will turn blue and the ESC LEDs of the aircraft will blink red quickly, indicating the corresponding aircraft has been selected.

Multi-Aircraft Operations

1. Select the desired aircraft by switching control.
2. Tap the status box of the selected aircraft, then tap  on the left of the screen, or tap  on top of the screen to select and use an operation in the "Field" tag. Perform the operation after tapping Rectify Offset and setting operation parameters. The selected flight routes data will be uploaded to the aircraft.
3. User an operation to each aircraft. Tap  to show the status boxes of all the aircraft and tap another status box to switch to the corresponding aircraft.
4. Tap Start after using operations for all the aircraft. Users can slide the sliders for each aircraft in the prompted window or slide the slider for all aircraft at the bottom position to take off all the aircraft and start operations at the same time.
5. If there is any emergency during operation, toggle the Pause Switch on the remote controller to brake all the aircraft. Then all Route operations will be paused and the aircraft will hover in place and can be controlled manually. To continue the operation, users should use the operation again in Executing tag in  icon.

Exit from Multi-Aircraft Control Mode

Users can exit from the mode through the following three methods.

Method 1: Link the remote controller to the only one desired aircraft according to the previous instructions (Single-Machine Pairing should be selected).

Method 2: Delete other aircraft and remain the only one aircraft in the Linked Aircraft list. So the remote controller can control this aircraft only and perform operations of other operation modes.

Method 3: Power off the other aircraft that don't need control and power on the only one desired aircraft. So the remote controller can control this aircraft only and perform operations of other operation modes. Note: if power on the other aircraft again, the remote controller and the linked aircraft will enter Multi-Aircraft Control mode automatically. Exit from this mode completely through method 1 or 2 if needed.

DJI MG App

The DJI MG app is designed for agricultural applications and is able to display the system status and configure various settings. After planning a field via the app's intelligent operation planning system, the aircraft can operate automatically following the produced flight route.

Main Screen



1. Plan a Field | Execute Operation

Plan a Field: Tap the button and then select planning method to plan a field.

Execute Operation: Tap to enter Operation View to view the aircraft status, configure settings, and switch between different operation modes.

2. Aircraft Connection Status

: Shows whether the aircraft is connected to the remote controller.

3. Menu

Tap to manage tasks, view user information, aircraft information, and configure general settings.

: Task Management — View planned fields and operation progress. You can synchronize the local data with the data on the DJI Agricultural Management Platform.

: User Info — View user information of the account logged in.

: Aircraft Info — View the information of the connected aircraft and manuals.

: General Settings — Tap for settings such as units of measurement, network diagnosis, and Android system settings.

Operation View

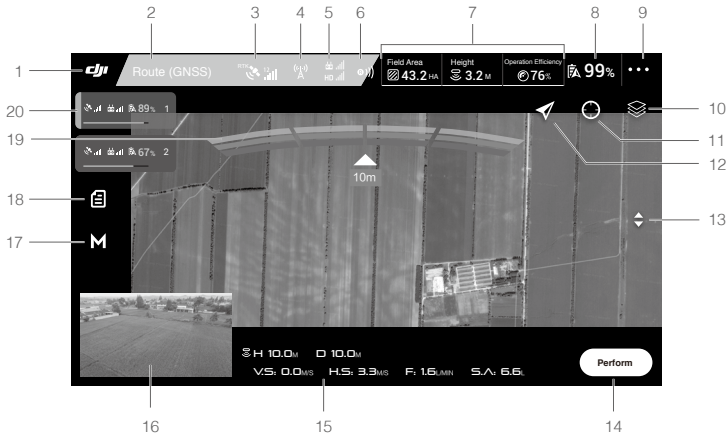

1. Main Screen

dji : Tap this icon to return to the main screen.

2. System Status

Route (GNSS) : Indicates current flight modes, operation modes, and warning messages.

3. GNSS Status

[GNSS icons] : Shows the current GNSS signal strength and number of satellites connected. When using RTK data, “RTK” will appear in the upper left corner.

4. RTK Status

Icons displayed when using RTK data. The display varies when using D-RTK 2 or Network RTK Service.

[RTK icon 1] : Displays RTK signal strength when using the D-RTK 2.

[RTK icon 2] : Indicates that the connection with the D-RTK 2 is abnormal. Refer to the prompts in the app.

[RTK icon 3] : Displays RTK signal strength when using the Network RTK Service.

[RTK icon 4] : Indicates that the connection with the Network RTK server is abnormal. Refer to the prompts in the app.

5. Control and HD Video Link Signal Strength

[Link icon] : Shows the signal strength of the control and HD video downlink connection between the aircraft and the remote controller.

6. Radar Module Obstacle Avoidance Function Status

[Obstacle icon] : Shows the working status of the obstacle avoidance function.

7. Operation Parameters

Shows parameters of current spraying operation. The display will vary according to operation mode.

[Field Area icon] : Field Area — Shows the total plan area value when planning fields for Route operations via the intelligent operation planning system.

 : ① Plan Area — Shows the value of the actual area of the produced flight route after planning fields. There is the following formula: Plan Area = Field Area - Obstacle Area - Collision Avoidance Safety Margin zone. ② Sprayed Area — Shows the value of the area already sprayed (only available when using Route operation or A-B Route operation).

 : Obstacle Area — Shows the area value of the obstacles measured when planning fields for Route operations.

 : Operation Type and Efficiency — Shows operation type and efficiency settings in Route, A-B Route or M+ mode. Tap to set Pesticide Usage for Spray, choose Efficient or Effective mode, and use the slider to adjust operation efficiency.

 : Height — When altitude stabilization function of the radar module is enabled, shows the preset height between the aircraft and the object under it. Appears in all modes except Manual operation mode. Tap to adjust the height.

 : Line Spacing — Shows the preset distance when flying left or right in Route, A-B Route or M+ mode. Tap to adjust the value. Note that for Route operations, the value can only be adjusted before performing an operation.

8. Battery Level

 **99%** : Shows the current battery level. Tap to set the Low Battery Warning threshold and view battery information.

9. More Settings

Tap **•••** to enter the extended menu to view and adjust the parameters of all other settings.

 : Aircraft Settings — Includes spraying completed action, lock the heading in M+, RC signal lost action, operation completed action, Home Point settings, Return to Home altitude, maximum altitude, distance limit, advanced settings, etc.

 : Spraying System Settings — Includes nozzle model, flow, air detector calibration, spraying system data display.

RTK : RTK Settings — Includes RTK module switch, RTK signal method and the corresponding settings for each method.

 : Radar Settings — Includes altitude stabilization, obstacle avoidance, terrain mode and obstacle display mode.

 : RC Settings — Includes RC calibration, stick mode, RC custom key and linking.

HD : Image Transfer Settings — Includes channel mode and sweep frequency chart.

 : Aircraft Battery — Includes Low Battery Warning, battery information, etc.

••• : General Settings — Includes map settings, flight route display, etc.

10. Map Mode

 : Tap to switch among Standard, Satellite, or Night modes.

11. Location Follow

 : Tap to center the map around the aircraft's location at all times, following its location update.

12. Location

 : Tap to center the map around the aircraft's location or the latest recorded Home Point.

13. Map Zoom In/Out

 : Tap to show the slider, and then slide it to zoom in or out.

14. Operation Control Buttons

Buttons to control during different operation types, including measure an operation area, use, perform, pause, or end an operation, etc.

15. Flight Parameters

 **H** : When the altitude stabilization function of the radar module is enabled, shows the preset height between the aircraft and the object underneath it.

 **D** : Horizontal distance from the aircraft to the Home Point.

 **VS** : Movement speed across a vertical distance.

 **HS** : Movement speed across a horizontal distance.

 **F** : Pesticide flow rate.

 **S.A** : The sprayed amount of the liquid. The data is erased if the aircraft is powered off. The sprayed amount resets to zero when the aircraft is powered on again.

16. FPV Camera View

Displays the real-time image from the FPV camera. Tap to switch between the Map View and the Camera View.

17. Operation Mode Switch Button

 **M / M⁺ / AB** : Tap to switch between Manual (M), Manual Plus (M+), and A-B Route (AB) operation modes.

18. Operation List / Point A/B

 : Operation List — Icon displayed in M operation mode. Tap to view the planned fields and operations in progress and use operations.

 : Point A/B — Icon displayed in AB operation mode. Tap to record Point A or B. The color of the icon will change from grey to purple to indicate successful recording. Tap to clear the recorded Point A and B.

19. Obstacle Detection Status

Shows information on the detected obstacles when the obstacle avoidance function of the radar module is enabled. Front obstacle information appears on the upper screen, and rear obstacle information appears on the lower screen. Red, orange, yellow, and green bars indicate the distance of obstacles in succession. The value indicates the distance between the aircraft and the nearest obstacle.

20. Aircraft Status Box in Multi-Aircraft Control Mode

Displays the status of all the connected aircraft sorted by number when using Multi-Aircraft Control function. Tap to switch the selected aircraft and the left side of the box will turn blue.

Aircraft

Profile

The MG-1P / MG-1P RTK uses DJI's dedicated A3 Flight Controller to provide multiple operation modes for various applications. The second generation high-precision radar with integrated obstacle avoidance radar module and forward, backward, and downward altitude stabilization radar modules provides obstacle sensing and avoidance functions, and guides the aircraft to maintain a constant distance above crops in specific operation modes. Functions such as operation resumption, system data protection, empty tank warning, Return to Home (RTH) and low battery level warning are also available. The MG-1P RTK has a built-in DJI Onboard D-RTK, providing more accurate data for centimeter-level positioning to ensure more precise and stable flight when used with the DJI D-RTK 2.

-
- ⚠ • When using your MG-1P / MG-1P RTK for the first time, activate it in the DJI MG app. Your DJI account and internet connection are required.
 - Effective use of pesticides relies on pesticide density, spray rate, spray distance, aircraft speed, wind speed and wind direction. Consider all factors when using pesticides.
 - Always fly at an appropriate height above crops to avoid damage.
-

Flight Modes

The aircraft will fly in P-mode by default.

P-mode (Positioning): The aircraft uses GNSS for positioning. It will revert to A-mode when GNSS signal is weak.

A-mode (Attitude): GNSS is NOT used for positioning and aircraft can only maintain altitude using the barometer. It enters A-mode only when there is weak GNSS signal or when the compass experiences interference.

Attitude Mode Warning

In A-mode, the aircraft cannot position and is easily affected by its surroundings, which may result in horizontal shifting. Use the remote controller to position the aircraft.

Maneuvering the aircraft in A-mode can be difficult. Avoid flying in areas where GNSS signal is weak, or in confined spaces. The aircraft will otherwise be forced to enter A-mode, leading to potential flight risks, please land it in a safe place as soon as possible.

Operation Modes

The MG-1P / MG-1P RTK provides Route, A-B Route, Manual, and Manual Plus operation modes. Switch to one of the three modes in the DJI MG app.

Route Operation Mode

After the operation area and obstacles have been measured, and settings have been configured, the DJI MG app uses a built-in Intelligent Operation Planning System to produce a flight route based on the user's input. Users can use the operation after field planning, and the aircraft can

operate automatically, following the generated flight route. Operation resumption, and the altitude stabilization and obstacle avoidance functions of the radar module are available in this mode. Use the app to adjust work efficiency (including flying speed and spray rates). Route operation mode is recommended for large spray areas.

Field Planning

The DJI MG app supports multiple planning methods to for various applications.

Fly the Aircraft

Users can fly the aircraft to desired positions and then use the button on the remote controller or app to add waypoints for operation area and obstacles measurements.

1. Power on the remote controller and enter the DJI MG app. Then power on the aircraft.
2. Tap Field Plan and then select Fly the aircraft.
3. Ensure that the System Status bar on top of the app displays Manual Route (GNSS) or Manual Route (RTK) (if an MG-1P RTK aircraft is in use and the D-RTK is enabled).
4. Tap Start Measuring in the lower right corner of the screen. Fly the aircraft alongside the boundary of the target field. Tap "Add Waypoint" or press Button C2 on the back of the remote controller at each corner of the field.
5. Mark any obstacles:

Use two methods below to mark obstacles if there is any in the target field.

 - ① Tap Start Obstacle Measurement onscreen or press the C1 button on the back of the remote controller, fly the aircraft around the obstacle, and then tap End Obstacle Measurement onscreen or press the C1 button again.
 - ② Tap Start Obstacle Measurement C1 onscreen or press the C1 button on the back of the remote controller, fly the aircraft around the obstacle, and tap Add Waypoint onscreen or press the C2 button to add waypoints. Tap End Obstacle Measurement onscreen or press the C1 button when finished.
6. Continue measuring the field by flying the aircraft alongside the boundary and adding waypoints at each corner of the field. Tap End Measurement when the field has been measured and all obstacles have been marked. The DJI MG app will produce a flight route according to the field's perimeter and obstacles.
7. Add calibration point(s): Fly the aircraft to the location of each calibration point. Tap Add Calibration Point onscreen.

The calibration points are used to offset the bias of the flight route caused by the positioning difference between the remote controller and aircraft. Choose at least one existing landmark as the fixed reference point(s) for calibration when executing the same operation. If none are available, use an easily identifiable object, such as a metal stake.

Walk with RC

Users should walk along the boundary of the field or the obstacles with the remote controller for measurements. Ensure that the aircraft is powered off when planning your flight route.

1. Power on the remote controller and enter the DJI MG app. Tap Field Plan and select Walk with RC.
2. Wait until GNSS signal is strong. Satellite counts should be no less than 10. Positioning accuracy may vary by +/-2 meters. Complete the remaining steps by walking with the remote controller following the same instructions as the "Fly the aircraft" method.

PC GS Pro / Handheld RTK

1. Refer to the corresponding manuals for field planning, and then share the planning data to DJI Agricultural Management Platform or store the data to the microSD card in the remote controller (if PC GS Pro is in use).
2. Using the planning data
 - a. Download from the platform:



To view the data on the platform, go to the main screen of the DJI MG app and tap  to synchronize data. Select the desired data for field editing.
 - b. Import from the microSD card:

Ensure that the remote controller is powered off. Insert the microSD card with the planning data from the PC GS Pro into the microSD card slot on the MG-1P remote controller. Then go to the main screen of the DJI MG app. Select the data in the prompted window and import it.

To view the data, go to  task management on the main screen. Select the desired data for field editing.

Field Editing

Tap any blank space onscreen to enter Edit Status.

1. Edit Waypoints
 - Move: Drag the waypoint to move.
 - Fine Tuning: Tap the waypoint to show Fine Tuning buttons. Tap to adjust.
 - Delete: Tap twice to delete a waypoint.
2. Adjust Route
 - Route Direction: Tap and drag the  icon near the route to adjust the flight direction of the produced route.
 - Line Spacing: Tap the  icon at the top of the screen to adjust the line spacing between two neighboring lines.
 - Collision Avoidance Safety Margin: Tap the corresponding button on bottom of the screen, and then adjust the safety margin between the route and the edge of the field or obstacle.
3. Edit Obstacles
 - Tap and hold the marked obstacle or the position that needs to mark an obstacle on the screen to choose the shape and size of the obstacle in the menu.
 - Tap the obstacle on the screen which has waypoints added, then follow the Edit Waypoints instructions to edit the added waypoints for complete obstacle information.
4. Tap Save Field, and then name the operation, choose crop, and configure other parameters.

Performing an Operation

1. Power on the remote controller. Place the aircraft at one of the previously set calibration points and then power it on.
2. Go to the main screen in the DJI MG app, and then tap Execute Operation to enter the Operation View.
3. Tap  to select a field in "Fields" tag, and then tap Invoke.
4. Adjust route: adjust the route direction, line spacing and collision avoidance safety margin, etc.
5. Tap Rectify Offset and then Rectify Aircraft Position, or adjust the route position via the Fine Tuning buttons and then tap OK.
6. Tap Start, set operation type, and then tap OK.

7. Takeoff and perform the operation.
 - ① If you fly to the targeted height, slide to start spraying.
 - ② If the aircraft is on the ground, slide to takeoff and start spraying.

- ⚠ • Be sure to takeoff in open areas.
- The operation will be automatically cancelled if the motors are started before beginning the operation. You will need to recall the operation in the task list.
 - Once started, the aircraft will fly to the starting point of the route and lock its heading in the direction of the first turning point for the duration of the flight path. Users cannot control the aircraft heading via the control stick during the operation.
 - The aircraft does not spray while flying along line spacing, but automatically sprays while flying along the rest of the route. Users can adjust operation efficiency (affecting the flying speed and spray rate) and height above the crops in the DJI MG app.
 - An operation can be paused by toggling the Pause switch. The aircraft will hover and record the breakpoint, and then the aircraft can be controlled manually. To continue the operation, use and perform the operation in the app and the aircraft will return to the breakpoint automatically and resume the operation. If switching between multiple flight modes is enabled in the app, the Pause Switch will be used as Flight Mode Switch. Therefore, the aircraft may enter A-mode (Attitude) when toggling the switch. Make sure to operate the aircraft with caution.
 - The aircraft will hover at the ending point of the flight route after the operation is completed. Instead of hovering the aircraft can also be set to perform other flight actions in the app.

A-B Route Operation Mode

In A-B Route operation mode, the aircraft will travel along a pre-planned route. Operation resumption, data protection, and the altitude stabilization and obstacle avoidance functions of the radar module are available in this mode. Use the app to adjust operation efficiency (affecting the flying speed and spray rate). A-B Route operation mode is recommended for large, rectangular spray areas.

Operation Route

The aircraft travels along a pre-designated square zig-zag route after recording turning points A and B. Under optimal working conditions, the obstacle avoidance function is available and the aircraft maintains distance from the vegetation. The length of the dotted lines, called Line Spacing, can be adjusted in the DJI MG app.

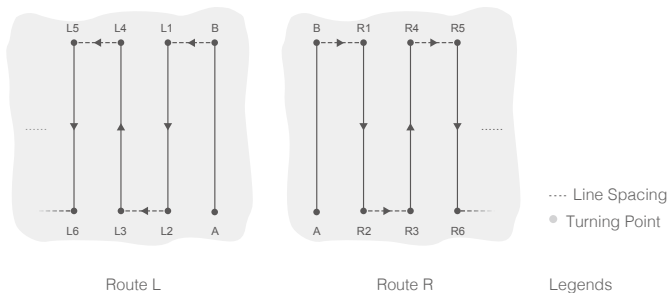

Operation Procedure

-  • Maintain line of sight of the aircraft at all times.
 - Ensure that the GNSS signal is strong. Otherwise, A-B Route operation mode may be unreliable.
-

-  Always inspect operating environments before flying.
-

Set the operation mode switch button to M (Manual operation mode) when a strong GNSS signal is present and the onscreen display is Manual Route (GNSS) or Manual Route (RTK). Then fly the aircraft to a proper height.

1. Record Points A and B in Order

Fly the aircraft to the starting point, depicted as Point A/B, hover, and then press Button A/B on the remote controller or tap Point A/B onscreen. The icon for Point A/B will change from gray to purple and the Aircraft Status Indicators will blink red/green after recording the starting points.

-  • Points A and B cannot be recorded if the spray tank is empty.
 - Be sure to record Point A first and then record Point B and that the distance between Point A and B should be more than 1 m.
 - Update Point B by flying the aircraft to a new position to record. Note that if you update Point A, you must also update Point B.
 - It is recommended to keep the direction of Point A to B parallel to one side of the rectangular spray area for optimal effect.
-

-  • After recording Point A, there will be a menu prompt for operation type settings. Set the amount of pesticide per acre, operation type, Banked Turning, etc. Use the slider to adjust operation efficiency. During the operation, tap the icon at the top of the screen to adjust parameters. You can also adjust operation efficiency via the Settings dial on the remote controller.
 - The DJI MG app will display an icon of line spacing after Point A and B are recorded. Tap to adjust the value. The line spacing cannot be adjusted during operation. Switch to Manual operation mode to adjust the value, then go back to A-B Route operation mode.
-

2. Select the Route

After Point A and B are recorded, the app produces Route R by default. Tap Direction on the lower right corner of the screen to switch to Route L.

3. Configuring Aircraft Altitude

Tap  on top of the screen to set the desired height above the vegetation. Under optimal working conditions, the radar module will start working automatically and maintain the spraying distance between aircraft and vegetation after performing the operation. Refer to [Radar Module \(p. 38\)](#) for details.

4. Performing an Operation

Tap Start on the lower right corner and slide to start the operation.

-  • If, after recording Points A and B, you fly the aircraft more than five meters away from Point B, Resume will appear on the lower right corner of the screen. Tap Resume, and the aircraft will automatically fly to Point B to perform the operation.
-

-
- ⚠ • If the GNSS signal is weak during the operation, the aircraft will enter Attitude mode and exit from A-B Route operation mode. Operate the aircraft with caution. The operation can be resumed after GNSS signal is recovered.
 - If you press the A or B buttons during operation while the flying speed of the aircraft is lower than 0.3 m/s, the data for Points A and B of the current route will be erased and the aircraft will hover in place.
-
- ☀ • The line spacing can be customized from 3-10 m in DJI MG. It is set to a length of 5 m by default.
 - The nose of the aircraft will always point from Point A to Point B regardless of flight direction. Users cannot control the aircraft heading via the control stick during the operation.
 - When using the control sticks to control the aircraft in A-B Route operation mode, the aircraft will automatically switch to Manual operation mode, complete corresponding flight behavior, and then hover. To resume the operation, tap Resume onscreen. The aircraft will resume flying along the operation route. Refer to [Operation Resumption \(p. 36\)](#) for details.
 - Even though the heading of the aircraft cannot be adjusted, use the control sticks to avoid obstacles if obstacle avoidance function of the radar module is disabled. Refer to [Manual Obstacle Avoidance \(p. 37\)](#) for details.
 - During the operation, the aircraft doesn't spray liquid while flying along the direction of the line spacing, and it automatically sprays liquid while flying along the rest parts of the route.
-

Manual Operation Mode

Tap the operation mode switch button in the app and select M to enter Manual operation mode. You can control all the movements of the aircraft, spray liquid via the remote controller's Spray button, and adjust the spray rate via the dial. Refer to [Controlling the Spraying System \(p. 21\)](#) for details. Manual operation mode is ideal when the operating area is small.

Manual Plus Operation Mode

Tap the operation mode switch button in the app and select M+ to enter Manual Plus operation mode. The aircraft's maximum flying speed is 7 m/s (customizable in the DJI MG app), the heading is locked, and all other movement can be manually controlled in this mode. Users can disable M+ heading lock in the app. Under optimal working conditions, the radar module will maintain the spraying distance between aircraft and vegetation if altitude stabilization function is enabled. Press the corresponding buttons onscreen or C1 or C2 buttons on the remote controller (if customized) to steer the aircraft left or right. The aircraft automatically sprays when accelerating forward, backward or diagonally, but does not spray when flying right or left. Manual Plus operation is ideal for irregularly-shaped operating areas.

-
- ☀ • The line spacing cannot be adjusted during operation. Switch to Manual operation mode to adjust the value, then go back to Manual Plus operation mode.
 - Spray rate will be adjusted automatically according to the flying speed.
 - Operation efficiency (affecting the maximum flying speed and maximum spray rate) and height above the vegetation can be adjusted in the DJI MG app.
 - Please fly with caution when steering the aircraft using the app or the C1 or C2 buttons because obstacles on both sides of the aircraft may not be detected if they are in the radar module's blind spots.
-

Operation Resumption

When exiting a Route or a A-B Route operation, the aircraft will record a breakpoint. The Operation Resumption function allows you to pause an operation temporarily (e.g., to refill the spray, change battery, and avoid obstacles manually) and then resume operation at the breakpoint.

Recording a Breakpoint

Exit a Route or A-B Route operation through one of the following methods and the aircraft records its location as a breakpoint if GNSS signal is strong:

1. Tap the Pause or End button on the lower right corner of the screen. Note: tapping the End button during an A-B Route operation does not make the aircraft record a breakpoint. The operation ends immediately and cannot be resumed.
2. Initialize the RTH procedure.
3. Toggle the Pause switch / Flight Mode switch.
4. Push the Pitch or Roll stick in any direction on the remote controller.
5. Obstacle detected. The aircraft brakes and enters obstacle avoidance mode.
6. Radar module error detected when its obstacle avoidance function is enabled.
7. The aircraft reaches its distance limit or altitude limit.
8. Empty tank.
9. If the GNSS signal is weak, the aircraft enters Attitude mode and exits the Route or A-B Route operation. The last position where there was a strong GNSS signal is recorded as a breakpoint.

-
-  • Ensure that GNSS signal is strong when using the Operation Resumption function. Otherwise, the aircraft cannot record and return to the breakpoint.
- The breakpoint is updated as long as it meets one of the above conditions.
 - If the operation is paused for longer than 20 minutes during an A-B Route operation, the system will automatically switch to Manual operation mode and erase the breakpoint.
-

Resume Operation

1. Exit a Route or A-B Route operation through one of the above methods. The aircraft records the current location as the breakpoint.
2. Fly the aircraft to a safe location after operating the aircraft or removing the conditions for recording a breakpoint.
3. Tap Resume on the lower right corner of the screen to continue the operation. If the End button is used to exit a Route operation, to recall the operation in Executing tag in Operation List is required for operation resumption.
4. Return Route
If the aircraft is in the operating area, there will be prompt in the DJI MG app. Users can select from returning to the breakpoint or the operating route along a path vertical to the operating route. If the aircraft is out of the operating area, it will return straight to the breakpoint and resume operation.
5. If obstacle avoidance is required during the return procedure, users can control the aircraft forwards, backwards, left, and right. Refer to Manual Obstacle Avoidance for details.

System Data Protection

In Route or A-B Route operation mode, the System Data Protection feature enables the aircraft to retain vital system data (e.g., operation progress, breakpoint, Point A, Point B) after the aircraft is powered off for a battery replacement or spray refill. Follow the instructions in Operation Resumption to resume the operation after restarting the aircraft.

During Route operations, in situations such as when the app crashes or the remote controller disconnects from the aircraft, the breakpoint will be recorded by the flight controller and can be recovered in the app once the aircraft is reconnected. Go to Operation View and select ●●● > ⌘ > “Advanced Settings”, and tap “Continue Unfinished Task”. Then recall the operation in Executing tag in Operation List.

Radar Module

Profile

The second generation high-precision radar with integrated obstacle avoidance radar module and forward, backward, and downward altitude stabilization radar modules provides improved obstacle sensing and terrain following capabilities. In an optimal operating environment, the radar module can predict the distance between the aircraft and the vegetation or other surface in forward, rear, and downward directions to fly at a constant distance to ensure even spraying and it can also detect obstacles 30 meters away from the aircraft. The radar functions are enabled by default, and can be disabled in the DJI MG app. When enabled, the aircraft will fly above the vegetation at a constant spraying distance in Route, A-B Route and Manual Plus operation modes. In Manual operation mode, the radar module can also measure the spraying distance above the vegetation or other surface, but the aircraft will not be able to fly at a constant spraying distance. The obstacle avoidance function can be used in any mode.

Detection Range

The detection range of the Obstacle Avoidance Radar is depicted as follows. Note that the aircraft cannot sense obstacles that are not within detection range. Please fly with caution.

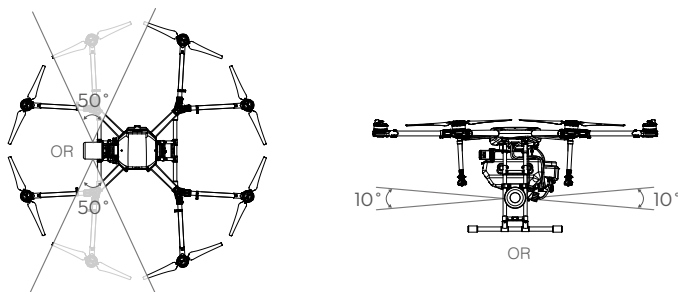

-
-  The horizontal FOV of the radar module is theoretically 50°. The range may fluctuate between 25° and 50°, however, depending on the size, material, distance, and other factors of objects.
-

Obstacle Avoidance Function Usage

There are two scenarios for obstacle avoidance:

1. The aircraft begins to slow down when it detects an obstacle is 15 m away and hovers in place when 2.5 m away from the obstacle. Users can not accelerate in the direction of the obstacle, but can fly in a direction away from the obstacle.
2. The aircraft immediately brakes and hovers if it detects an obstacle nearby. Users cannot control the aircraft when it is braking.

When the aircraft is hovering, it is in obstacle avoidance mode. Users can fly in a direction away from the obstacle to exit obstacle avoidance mode and regain full control of the aircraft.

-  Obstacle avoidance during RTH is different from the above descriptions. Refer to [Obstacle Avoidance During RTH](#) (p. 42) for details.
-

Altitude Stabilization Function Usage

1. Ensure that you have enabled the altitude stabilization function of the radar module in the DJI MG app.
2. Configure the desired spraying distance.
3. Enter the desired operation mode. If the operating environment is ideal, the aircraft will fly above the vegetation at the preset height.

- ⚠ • In Manual operation mode, users have complete control of the aircraft. Pay attention to the flying speed and direction when operating. Make sure to be aware of the surrounding environment and avoid the radar module's blind spots.
- The obstacle avoidance functions are disabled in Attitude mode.
- Obstacle avoidance is adversely affected when aircraft pitch exceeds 15°. Please fly with care.
- Obstacle avoidance is disabled when flying over surfaces at a height of < 0.8 m.
- Aircraft speed should not exceed 5 m/s when flying over surfaces at a height of < 2 m. Aircraft speed should not exceed 7 m/s when flying at a height of ≥ 2 m. Obstacle avoidance will otherwise be greatly compromised or even disabled.
- The radar module enables the aircraft to maintain a fixed distance from vegetation only within its working range. Observe the aircraft's distance from the vegetation at all times.
- Operate with extra caution when flying over inclined surfaces (depending on aircraft speed). Recommended maximum inclination at different speeds: 10° at 1 m/s, 6° at 3 m/s and 3° at 5 m/s.
- Please maintain full control of the aircraft at all times. DO NOT rely solely on the DJI MG app. Keep the aircraft within a visual line of sight observing it at all times. Use your discretion to operate it manually to avoid obstacles.
- Comply with local radio transmission laws and regulations.
- The radar module can only function properly in flat landscapes and cannot function in sloping landscapes with inclinations more than 10° or in landscapes with sudden changes in elevation.

- ⚠ • To avoid radar interference, DO NOT use several aircraft within a short distance of each other.
- Before use, ensure that the outer protective cover is not cracked, chipped, sunken, or misshapen.
- DO NOT attempt to disassemble any part of the radar module that has already been mounted prior to shipping.
- The radar module is a precision instrument. DO NOT squeeze, tap or hit.

- ☀ • If the radar module frequently detects obstacles incorrectly, first check to make sure the mounting bracket and the aircraft landing gear are properly secured. Second, perform the IMU calibration. If this still doesn't work, please contact DJI Support or a DJI Authorized Dealer.
- Keep the protective cover of the radar module clean. Clean the surface with a soft damp cloth and air dry before using again.

Empty Tank







Profile

An indication appears in the DJI MG app and the aircraft hovers in place when the spray tank is empty. In Route, A-B Route, and Manual Plus operation modes the aircraft can also be set to ascend or Return to Home instead of hovering.

Usage

1. When an empty tank warning appears in the app, the sprinklers will automatically turn off.
2. Make sure that the aircraft is in Manual operation mode, land, and then stop the motors. Next, refill the spray tank and tightly secure the cover.
3. Take off in Manual operation mode and fly the aircraft to where the operation was interrupted. Enter the desired mode to continue the operation.

Return to Home (RTH)

<p>1. Record Home Point (HP)</p>  <p>Blinks green or purple</p>	<p>2. Confirm Home Point</p>  <p>Blinks green six times</p>	<p>3. Remote Controller Signal Lost</p>  <p>Blinks yellow</p>
<p>4. Signal Lost > 3 sec</p>  <p>Blinks yellow</p>	<p>5. Initiate RTH</p>  <p>Blinks yellow</p>	<p>6. Land After Hovering 5 sec</p>  <p>Blinks yellow</p>



Updating the Home Point

You can update the Home Point in the DJI MG app during flight. There are two options for setting the Home Point:

1. Set the aircraft's current coordinates as the Home Point.
2. Set the remote controller's current coordinates as the Home Point.





 Ensure the space above the remote controller's GNSS module (located beneath the DJI logo) is not obstructed and that there are no tall buildings around when updating the Home Point.

Follow the instructions below to update the Home Point:

1. Go to DJI MG > Operation View.
2. Tap  > , select  in Home Point settings to set the aircraft's current coordinates as the Home Point.

3. Tap ●●● > ⚙️, select 📍 in Home Point settings to set the remote controller's current coordinates as the Home Point.
4. The Aircraft Status Indicators will blink green to indicate that the new Home Point has successfully been set.

RTH Safety Notices

	<p>The aircraft cannot avoid obstacles during RTH if the operating environment is not suitable for the radar module. Users can only control the speed and altitude of the aircraft. If the aircraft is in risk of collision, exit RTH immediately. Before each flight, it is important to set an RTH altitude that is appropriate for the given environment. Go to DJI MG > Operation View > ●●● > ⚙️ > Set Return to Home Altitude.</p>
	<p>If the aircraft is flying under 5 meters and RTH (including Smart and Failsafe RTH) is triggered, the aircraft will first automatically ascend to 5 meters from the current altitude. You cannot control the aircraft during this ascent. In Smart RTH, you can exit RTH to cancel automatic ascent by pressing the RTH button once.</p>
	<p>The aircraft automatically descends and lands if RTH is triggered when the aircraft flies within a 5 m radius of the Home Point.</p>
	<p>The aircraft cannot return to the Home Point when GNSS signal is weak (📶 displays red) or is unavailable.</p>
	<p>When the RTH altitude is set to more than 5 m and the aircraft is ascending between 5 m and the preset RTH altitude, the aircraft will stop ascending and immediately return to the Home Point if you push the throttle stick.</p>

Obstacle Avoidance During RTH

During RTH, if there is an obstacle within 20 m of the aircraft, the aircraft decelerates and then stops and hovers. While decelerating, if the aircraft comes within 6 m of the obstacle it flies backward to a distance of around 6 m from the obstacle and hovers. The aircraft then exits the RTH procedure and waits for pilot commands.

Landing Protection Function

Landing Protection will activate during auto landing.

1. After the aircraft arrives at the Home Point, it will descend to a position three meters above the ground and hover.
2. Control the pitch and roll sticks to adjust the aircraft position and ensure the ground is suitable for landing.
3. Pull down the throttle stick or follow the onscreen instructions in the DJI MG app to land the aircraft.

Low Battery Warnings

There are two low battery warnings:

1. Low Battery Warning: The Aircraft Status Indicators slowly blink red. Fly the aircraft back and land it as soon as possible, stop the motors, and replace the batteries.
2. Critical Battery Warning: the Aircraft Status Indicators rapidly blink red. The aircraft will begin to descend and land automatically.



Users can set the threshold of both low battery level warnings.

RTK Functions (for MG-1P RTK only)

The MG-1P RTK has a built-in DJI Onboard D-RTK, which provides more accurate data for centimeter-level positioning to improve agricultural operation when using with DJI D-RTK 2 Mobile Station. The aircraft's heading reference from the dual antennas of the onboard D-RTK is more accurate than a standard compass sensor and can withstand magnetic interference from metal structures.

Enable/Disable RTK

Ensure that the "RTK Function" is enabled and RTK service type is correctly set (D-RTK 2 Mobile Station or Network RTK service) before each use. Go to Operation View in the DJI MG app > ●●● > RTK to view and set.

Make sure to disable RTK function if not in use. Otherwise, the aircraft will not be able to take off when there is no differential data.

Using with the DJI D-RTK 2 Mobile Station

1. Refer to the D-RTK 2 Mobile Station User Guide to complete linking between the aircraft and the mobile station and setup of the mobile station.
2. Power on the mobile station and wait for the system to start searching for satellites. The RTK status icon on top of the Operation View in the DJI MG app will show  to indicate that the aircraft has obtained and used the differential data from the mobile station.

Using with the Network RTK Service

The Network RTK service uses the remote controller instead of the base station to connect to an approved Network RTK server for differential data. Keep the remote controller on and connected to the Internet when using this function.

1. Ensure that the remote controller is connected to the aircraft and has access to the Internet.
2. Go to Operation View in the DJI MG app > ●●● > RTK, select the RTK service type to custom network RTK, and then input the network information.
3. Wait for the remote controller to be connected with the Network RTK server. The RTK status icon on top of the Operation View in the DJI GS RTK app will show  to indicate that the aircraft has obtained and used the RTK data from the server.

Flight

Operation Environment

1. DO NOT use the aircraft in adverse weather conditions, such as heavy rain (precipitation rate exceeding 25 mm or 0.98 in within a 12-hour period), high winds exceeding 17 mph (28 kph), fog, snow, lightning, tornadoes, or hurricanes.
2. Only fly in open areas. Tall buildings and steel structures may affect the accuracy of the compass and the GNSS signal.
3. Maintain line of sight of the aircraft at all times, and avoid flying near obstacles, crowds, animals, trees, and bodies of water.
4. Avoid flying in areas with high levels of electromagnetism, including mobile phone base stations and radio transmission towers.
5. Ensure that there is a strong GNSS signal during operations.
6. DO NOT operate the aircraft indoors.
7. In the Earth's polar regions the aircraft can only operate in Attitude mode.

Flight Limits and No-Fly Zones

Users can set flight limits on height and distance.

Unmanned aerial vehicle (UAV) operators should abide by the regulations from self-regulatory organizations such as the International Civil Aviation Organization, the Federal Aviation Administration, and their local aviation authorities. For safety reasons, flight limits are enabled by default to help users operate this aircraft safely and legally.

When operating with a strong GNSS signal, the height and distance limits and no-fly zones work together to monitor flight. With a weak GNSS signal, only the height limit prevents the aircraft from going above 30 meters.

Maximum Height and Radius Limits

Users can change the maximum height and radius limits in the DJI MG app. Once complete, your aircraft will fly in a restricted cylinder that is determined by these settings. The tables below show the details of these limits.

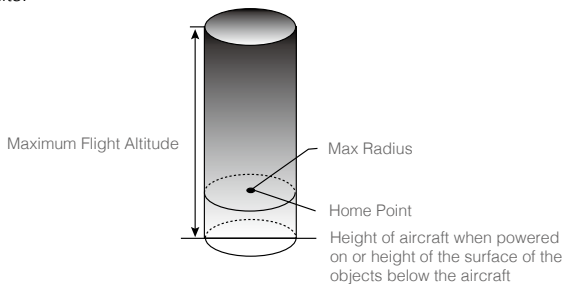

With a strong GNSS signal

Flight Limits

Max Height	Flight altitude must be below the preset height.
Max Radius	Flight distance must be within the max radius.

With a weak GNSS signal

	Flight Limits
Max Height	Flight altitude must be below the preset height.
Max Radius	No limits.

- ⚠ If you fly into a no-fly zone, you can still control the aircraft, but cannot fly it further.
- If the aircraft loses GNSS signal and flies out of the max radius but regains GNSS signal afterwards, it will fly back within range automatically.



No-Fly Zones

Detailed no-fly zones are listed on the DJI official website at <http://fllysafe.dji.com/no-fly>. No-fly zones are divided into airports and restricted areas. Airports include major airports and flying fields where manned aircraft operate at low altitudes. Restricted areas include borders between countries or sensitive sites. The details of the no-fly zones are explained below (GNSS required):

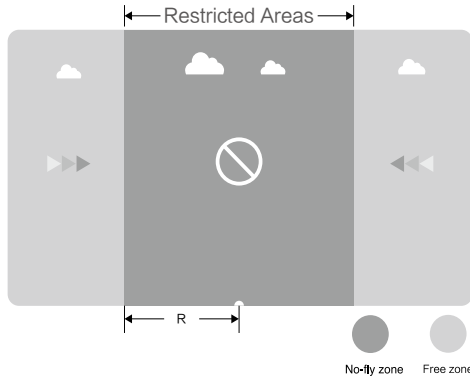
R mi around the restricted area (depending on the regulation) is a no-fly zone, inside which takeoff and flight are prohibited.



With a strong GNSS signal

Zone	Restriction	Aircraft Status Indicators
No-Fly Zone 	Motors will not start.	Blinking Red 
	If the aircraft loses GNSS signal and enters the restricted area but regains GNSS signal afterwards, the aircraft will enter semi-automatic descent and land.	
Free Zone 	No flight restrictions.	None.

 **Semi-Automatic Descent:** All stick commands except the throttle stick command are available during descent and landing. Motors will automatically stop after landing.

-  • When operating in no-fly zones, the Aircraft Status Indicators will blink red slowly and continue for 5 seconds, then switch to indicate the current flying status and continue for 12 seconds, at which point it will switch back to blinking red slowly.
 - For safety reasons, DO NOT fly near airports, highways, railway stations, railway lines, city centers, or other busy areas. Ensure the aircraft is visible at all times.
-

Pre-Flight Checklist

1. The remote controller, aircraft battery is fully charged.
2. The pesticides required are adequate.
3. The position of aircraft battery is secured.
4. All parts are mounted securely.
5. All cables are connected correctly and firmly.
6. Propellers are unfolded and mounted onto the motors securely; frame arms are unfolded and arm sleeves are firmly tightened.
7. Spraying system is without any blockage.
8. Sprinkler hoses are clear from bubbles. Discharge bubbles, as they may lead to operation problems. Loosen the valve on the side of the spray nozzle and start the pump. Then tighten the valve and the sprinkler will work properly.

Calibrating the Compass

Because the aircraft's compass inside the landing gear leg is highly sensitive, it requires calibration before your first flight and regularly to ensure optimal flight performance. Lack of calibration can lead to abnormal compass data, causing poor flight performance or failure.

-  • DO NOT calibrate your compass where there is a chance of strong magnetic interference, such as magnetite quarries, parking structures, and underground steel reinforcements.
 - DO NOT carry ferromagnetic objects such as cellular phones with you during calibration.
 - DO NOT calibrate near massive metal objects.
 - DO NOT calibrate in an indoor space.
-

Calibration Procedures

Choose an open space to carry out the following procedures. It is recommended to calibrate the compass with an empty tank.

1. Go to the app and tap Perform an Operation to enter Operation View. Tap the Aircraft Status Bar at the top of the screen and select Calibration in the Aircraft Status List, then follow the on-screen instructions.
2. Hold the aircraft horizontally and rotate it 360 degrees around a vertical axis until the Aircraft Status Indicators change to solid green and the display goes to the next step in the app.
3. Hold the aircraft vertically, with its nose pointing upward, and rotate it 360 degrees around a vertical axis.

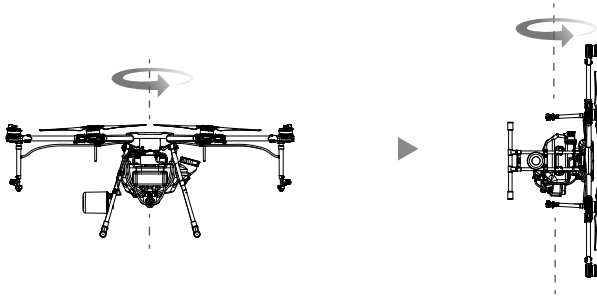

4. The Aircraft Status Indicators show the current flight mode and the calibration page disappears in the app when calibration is complete. If the Aircraft Status Indicators blink red or a calibration failure is displayed in the app, repeat the steps above to calibrate the compass.

When to Recalibrate

1. Compass data is abnormal, and the Aircraft Status Indicators are alternately blinking red and yellow.
2. Flying in a new location, or a location that is different from your last flight.
3. The mechanical structure of the aircraft has changed.
4. Severe drifting occurs in flight (e.g., the aircraft has difficulty flying in a straight line).

Calibrating the Spraying System

Be sure to calibrate the spraying system before your first spray operation, or else it will adversely affect spraying performance. Use the included measuring cup to ensure accuracy. Calibration takes around 6 to 14 minutes.

1. Preparation before calibration: If there are any bubbles in the hoses, discharge them before calibrating. If there are no bubbles proceed directly to calibration.
 - ① Fill the spray tank with about 2 L of water.
 - ② Power on the remote controller and the aircraft.
 - ③ Loosen the four manual relief valves on the side of the sprinklers and press the Spray button on the remote controller until the bubbles in the hoses have been fully discharged.* Tighten the valves and press the Spray button to stop spraying.

* If the bubbles have still not been fully discharged after a long period of time, rotate the valve cover and remove it, then re-mount the cover once the bubbles have been fully discharged.

2. Spraying System Calibration

① Liquid level meter calibration

Pour about 1 L of water into the spray tank. In the DJI MG app go to Operation View > ... > , then tap Calibrate in Flow IMU settings.

Select Nozzle Model, select the correct model in the list (the standard nozzle is model XR11001VS), then tap Start Calibration. The aircraft will spray automatically, then when ready the app will indicate that the aircraft is ready for left pump calibration.

② Left pump calibration



Pour between 1 and 5 L of water into the spray tank, measuring the volume of water precisely using the measuring cup.

In the app, input the volume of the water you have poured into the tank. Be sure to input the precise value to avoid calibration bias. Tap Start Calibration and the aircraft will spray automatically, then when ready the app will indicate that the aircraft is ready for right pump calibration.

③ Right pump calibration

Repeat the procedure described above for right pump calibration. Once the app indicates that right pump calibration is complete, wait for a few more moments until the app indicates that the spraying system calibration procedure is totally complete.

3. Discharge any bubbles in the hoses using the same procedure as used when preparing for calibration.

 During calibration, tap ●●● >  to cancel. The accuracy of the flow meter will be the data before calibration.

When to Recalibrate

1. Installing a different nozzle model. Note: choose the corresponding model in the DJI MG app after replacing nozzles. Go to Operation View > ●●● >  for configuration.
2. Using a liquid of a different viscosity.
3. The error between the actual value and the theoretical value of the completed area is more than 15%.

Starting and Stopping the Motors

Starting the Motors

The Combination Stick Command (CSC) listed below is used to start and stop the motors. Ensure you perform the CSC in one continuous motion. The motors will begin to accelerate to an idle speed. Release both sticks simultaneously. Take off immediately after the motors are spinning, or else the aircraft may lose balance, drift, or even takeoff by itself and risk damage or harm.



Stopping the Motors

There are two methods to stop the motors.

1. When the aircraft has landed, push the throttle down and hold. The motors will stop after three seconds.



Throttle Stick (left stick in Mode 2)

- When the aircraft has landed, push the throttle stick down, then perform the CSC command to stop the motors. Release both sticks once the motors have stopped.

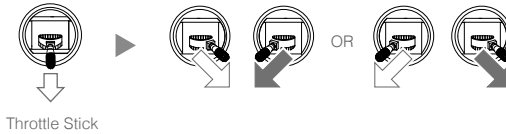

- ⚠ • Take off immediately after the motors are spinning, or else the aircraft may drift and cause damage or harm.
- Rotating propellers can be dangerous. DO NOT start the motors in narrow spaces or when there are people nearby.
- Always keep your hands on the remote controller when the motors are spinning.
- If you perform the CSC when the aircraft is airborne, the motors will stop and cause the aircraft to crash. Never stop the motors mid-flight, unless in emergency situations when doing so can reduce the risk of damage or harm.
- It is recommended to stop the motors via method 1. When using method 2 to stop the motors, the aircraft may tip if it doesn't touch the ground completely. Please use method 2 with caution.

Flight Test

- Place the aircraft near the operation area with the Aircraft Status Indicators facing you.
- Power on the remote controller. Then power on the aircraft.
- Ensure that the aircraft is connected to the remote controller.
- When the GNSS signal is strong, perform the CSC command to start the motors.
- When using with the MG-1P RTK aircraft:
 - Ensure that the RTK function is enabled and RTK service type is correctly set (D-RTK 2 Mobile Station or Network RTK service). Go to Operation View in the DJI MG app > ●●● > RTK to view and set.
 - Make sure to disable RTK function if not in use. Otherwise, the aircraft will not be able to take off when there is no differential data.
- Push the throttle stick up to take off.
- Select the desired operation or flight mode and spray liquid.
- Exit the operation to manually control the aircraft for landing. Hover over a level surface and gently pull down on the throttle stick to slowly descend.
- After landing, push the throttle down and hold. The motors will stop after three seconds.
- Power off the aircraft, and then power off the remote controller.

- ⚠ • When the Aircraft Status Indicators rapidly blink yellow during flight, the aircraft has entered Failsafe mode.
- The low battery level warning is triggered when the Aircraft Status Indicators slowly blink red. Fly the aircraft back and land it as soon as possible, stop the motors, and replace the battery. The critical low battery level warning is triggered when the Aircraft Status Indicators rapidly blink red. The aircraft will begin to automatically descend and land.

DJI Assistant 2 for MG

Configure settings of the basic parameters, copy flight records, and update aircraft and remote controller firmware in the DJI Assistant 2 for MG software.

Installation and Launching

1. Download the DJI Assistant 2 for MG installation file from the MG-1P download page:
<http://www.dji.com/mg-1p/info#downloads>
2. Install the software.
3. Launch DJI Assistant 2 for MG.

Using DJI Assistant 2 for MG

Connecting the Aircraft

Connect the Micro USB port of the aircraft to your computer with a Micro USB cable. Then power on the aircraft.

 Be sure to remove the propellers before using DJI Assistant 2 for MG.

Firmware Update

A DJI account is required for firmware updates. Login with your DJI account or register for one.

Basic Settings

Configure idle speed of and test the motor.

Tools

Enter SD card mode and copy the flight record.

Connecting the Remote Controller

Connect the USB-C port of the remote controller to your computer with a USB-C cable. Then power on the remote controller.

Firmware Update

A DJI account is required for firmware updates. Login with your DJI account or register for one.

-
-  • DO NOT power off the remote controller during the update.
• DO NOT perform the firmware update while the aircraft is in the air. Only carry out the firmware update when the aircraft is on the ground.
• The remote controller may become unlinked from the aircraft after the firmware update. Relink the remote controller and aircraft if necessary.
-

Appendix

Specifications

Airframe

Diagonal Wheelbase	1500 mm
Frame Arm Length	619 mm
Dimensions	MG-1P: 1460 × 1460 × 578 mm (Frame arms unfolded, propellers removed) 780 × 780 × 578 mm (Frame arms folded)
	MG-1P RTK: 1460 × 1460 × 616 mm (Frame arms unfolded, propellers removed) 780 × 780 × 616 mm (Frame arms folded)

Propulsion System

Motors

Stator Size	60 × 10 mm
KV	130 rpm/V
Max Thrust	5.1 kg/rotor
Max Power	770 W
Weight (With cooling fan)	255 g

ESCs

Max Allowable Current (Continuous)	25 A
Operating Voltage	50.4 V (12S LiPo)
Signal Frequency	30 to 450 Hz
Drive PWM Frequency	12 kHz

Foldable Propellers (21/21R)

Material	High-performance engineered plastics
Diameter × Pitch	21 × 7 inch
Weight	58 g

Spraying System

Spray Tank

Volume	10 L
Standard Operating Payload	10 kg
Max Battery Size	151 × 195 × 70 mm

Sprinkler Kits

Model	XR11001VS
Quantity	4
Max Spray Rate	0.45 L/min (Single nozzle, using water)
Spray Width	4 to 6 m (4 nozzles, 1.5 to 3 m above vegetation)
Droplet Size	XR11001VS: 130 - 250 µm (Depending on operating environment and spray rate)

High-Precision Radar Module













Model	RD2412R
-------	---------

Operating Frequency	CE / FCC / SRRC (China): 24.00 GHz to 24.25 GHz MIC (Japan) / KCC (Korea): 24.05 GHz to 24.25 GHz
Power Consumption	12 W
EIRP	CE / FCC / MIC / KCC: 20 dBm; SRRC: 13 dBm
Field of View (FOV)	Horizontal: 50°, Vertical: 10°
Altitude Detection and Stabilization	Detection Range: 1 to 30 m Stabilization Working Range: 1.5 to 10 m
Obstacle Avoidance System	Sensing Range: 1.5 to 30 m (varies according to the material, position, shape, and other properties of the obstacle) Operating Conditions: Flying higher than 1.5 m over the obstacle with speed lower than 7 m/s Safety Distance: 2.5 m Obstacle Avoidance Direction: Forward or backward
IP Rating	IP67
FPV Camera	
FOV	123° (H)
Resolution	1280×960 30p
Flight Parameters	
Operating Frequency	2.400 GHz to 2.483 GHz 5.725 GHz to 5.850 GHz (not supported in Japan)
EIRP	2.4 GHz FCC: < 26 dBm; CE / MIC / KCC / SRRC: < 20 dBm 5.8 GHz FCC / SRRC: < 26 dBm; CE / KCC: < 14 dBm
Total Weight (Excluding battery)	MG-1P: 9.8 kg, MG-1P RTK: 9.9 kg
Standard Takeoff Weight	MG-1P: 23.8 kg, MG-1P RTK: 23.9 kg
Max Takeoff Weight	24.8 kg (At sea level)
Max Thrust-Weight Ratio	1.71 (Takeoff weight of 23.8 kg)
Hovering Accuracy (Strong GNSS signal)	D-RTK enabled: horizontal ±10 cm, vertical ±10 cm D-RTK disabled: horizontal ±0.6 m, vertical ±0.3 m (±0.1 m, radar module enabled)
GNSS*	GPS+GLONASS
Battery	DJI approved battery pack (Model: MG-12000P)
Max Power Consumption	6400 W
Hovering Power Consumption	3800 W (Takeoff weight of 23.8 kg)
Hovering Time*	20 min (Takeoff weight of 13.8 kg with a 12000 mAh battery) 9 min (Takeoff weight of 23.8 kg with a 12000 mAh battery)
Max Operating Speed	7 m/s
Max Flying Speed	10 m/s (P-mode), 15 m/s (A-mode)
Max Wind Resistance	8 m/s
Max Service Ceiling Above Sea Level	2000 m
Operating Temperature	32° to 104° F (0° to 40° C)

* For the Asia-Pacific version of the MG-1P RTK, GNSS is GPS+GLONASS+BEIDOU when RTK is enabled. Estimated hovering time was measured at sea level and in wind speeds under 3 m/s. This value should be used for reference only.

Remote Controller	
Model	GL300N
Operating Frequency	2.400 GHz to 2.483 GHz 5.725 GHz to 5.850 GHz (not supported in Japan)
Max Transmitting Distance (unobstructed, free of interference)	FCC: 3.11 mi (5 km) CE / MIC / KCC / SRRC: 1.86 mi (3 km)
EIRP	2.4 GHz FCC: < 26 dBm; CE / MIC / KCC / SRRC: < 20 dBm 5.8 GHz FCC / SRRC: < 26 dBm; CE / KCC: < 14 dBm
Display Device	5.5 inch screen, 1920×1080, 1000 cd/m ² , Android system, 4G RAM+16G ROM
Supported SD Cards	microSD. Max Capacity: 128GB
Power Consumption	16 W (typical value)
Operating Temperature	14° to 104° F (-10° to 40° C)
Storage Temperature	Less than 3 months: -4° to 113° F (-20° to 45° C) More than 3 months: 72° to 82° F (22° to 28° C)
Charging Temperature	41° to 104° F (5° to 40° C)
Remote Controller Intelligent Battery	
Model	WB37-4920mAh-7.6V
Battery Type	LiPo battery
Capacity	4920 mAh
Voltage	7.6 V
Energy	37.39 Wh
Charging Temperature	41° to 104° F (5° to 40° C)
Charging Hub	
Model	WCH2
Input Voltage	17.3 - 26.2 V
Output Voltage and Current	8.7 V, 6 A; 5 V, 2 A
Operating Temperature	41° to 104° F (5° to 40° C)
AC Power Adapter	
Model	A14-057N1A
Voltage	17.4 V
Rated Power	57 W

Aircraft Status Indicators Description

Blinking Patterns	Description
 ·····	Blinking Red, Green and Yellow Self-checking
 ×4	Blinking Yellow for 4 times Warming up
 ·····	Slowly Blinking Yellow A-mode or P-mode (no GNSS)
 ·····	Slowly Blinking Green P-mode (GNSS)
 ·····	Alternately Blinking Blue and Green The aircraft is using RTK data for positioning.
 ·····	Rapidly Blinking Green The aircraft brakes and hovers to enter obstacle avoidance mode when an obstacle is detected.
 —	Solid Red System error. Restart the aircraft, if still not working, contact DJI Support or a DJI authorized dealer.
 ·····	Alternately Blinking Red and Yellow Abnormal compass data, compass calibration required
 ·····	Rapidly Blinking Red Several Times Point A recorded
 ·····	Rapidly Blinking Green Several Times Point B recorded
 ·····	Rapidly Blinking Yellow Remote controller signal lost
 ·····	Slowly Blinking Red Low battery level
 ·····	Rapidly Blinking Red Critical low battery level

Updating the Firmware

Users can update the firmware in the DJI Assistant 2 for MG. The DJI MG app can also be used to update the firmware of both the aircraft and remote controller, if using a firmware version of 01.04.0320 or above. Follow the instructions below.

1. Power on the remote controller and the aircraft. Ensure that the remote controller has access to the Internet.
2. Connect the USB-C port on the remote controller to the Micro USB port on the aircraft via a USB-C OTG cable and a Micro USB cable.
3. There will be a prompt on the lower right corner in the DJI MG app if there is new firmware. Tap the text to enter firmware page.
4. Select the desired firmware and tap Update to enter firmware information page.
5. Tap Download XXX (XXX indicates the firmware version) to download the firmware package for all the devices.
6. When the download is complete, tap Update XXX under each device to enter the update page for the corresponding device, then tap Install and wait for the update complete.
7. After successfully completing the update, restart the remote controller and the aircraft manually.

DJI Support
<http://www.dji.com/support>

This content is subject to change.

Download the latest version from
<http://www.dji.com/mg-1p>

If you have any questions about this document, please contact DJI by sending a message to **DocSupport@dji.com**.

AGRAS is a trademark of DJI.
Copyright © 2018 DJI All Rights Reserved.

