

MAVIC 2 PRO

Quick Start Guide

Kurzanleitung

Guía de inicio rápido

Guide de démarrage rapide

Guida rapida

Snelstartgids

Guia de início rápido

Краткое руководство пользователя

V1.0

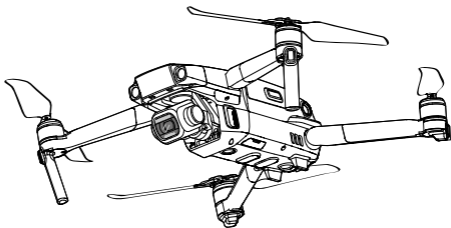

Contents

EN	Quick Start Guide	2
DE	Kurzanleitung	12
ES	Guía de inicio rápido	22
FR	Guide de démarrage rapide	32
IT	Guida di avvio rapido	42
NL	Snelstartgids	52
PT-PT	Guia de início rápido	62
RU	Краткое руководство пользователя	72

Aircraft

The DJI™ MAVIC™ 2 Pro features omnidirectional Vision Systems and Infrared Sensing Systems*, and a fully stabilized 3-axis gimbal with a 1" CMOS sensor camera (jointly developed by DJI and Hasselblad) that shoots 4K video and 20-megapixel photos. DJI signature technologies such as Obstacle Sensing and Intelligent Flight Modes like HyperLapse, ActiveTrack™ 2.0, QuickShot, Panorama, and Advanced Pilot Assistance Systems, help you capture complex shots effortlessly. The Mavic 2 Pro boasts a maximum flight speed of 44.7 mph (72 kph) and a maximum flight time** of 31 minutes.

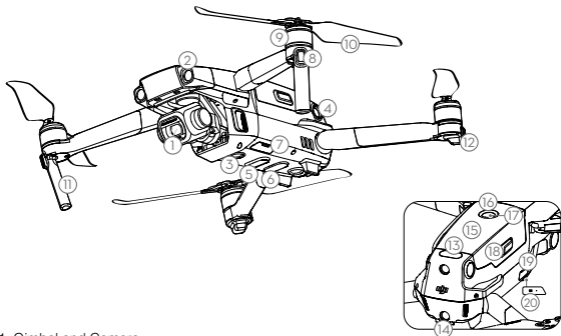

- | | | |
|-------------------------------------|------------------------------------|--|
| 1. Gimbal and Camera | 9. Motors | |
| 2. Forward Vision System | 10. Propellers | |
| 3. Downward Vision System | 11. Antennas | |
| 4. Lateral Vision System | 12. Aircraft Status Indicator | |
| 5. Downward Infrared Sensing System | 13. Upward Infrared Sensing System | 16. Battery Level LEDs |
| 6. Auxiliary Bottom Light | 14. Backward Vision System | 17. Power Button |
| 7. microSD Card Slot | 15. Intelligent Flight Battery | 18. Battery Buckles |
| 8. Front LEDs | | 19. USB-C Port |
| | | 20. Link Button/Linking Status Indicator |

* The Vision Systems and Infrared Sensing Systems are affected by surrounding conditions. Read the Disclaimer and Safety Guidelines, User Manual, and watch the tutorial videos in the DJI GO™ 4 app or on the official DJI website to learn more. <http://www.dji.com/mavic-2>

** Maximum flight time was tested in an environment with no wind while flying at a consistent 15.5 mph (25 kph). This value is for reference only.

Remote Controller

Built into the remote controller is the DJI's long-range transmission technology OCUSSYNC™ 2.0, offering a maximum transmission range of 5 mi (8 km) and displaying video from the aircraft to the DJI GO 4 app on your mobile device at up to 1080p. An on-board LCD screen gives real-time aircraft data information and the detachable control sticks make the remote controller easier to store.

Maximum run time: 2 hours and 15 minutes*



Folded

1. LCD Screen
2. Flight Pause Button
3. 5D Button
4. Removable Control Sticks
5. Power Button
6. Antennas
7. RTH Button
8. Control Sticks Storage Slot
9. Reserve Video-Downlink Port (USB)
10. Mobile Device Clamp
11. Flight Mode Switch

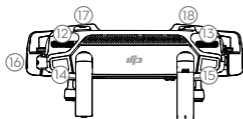
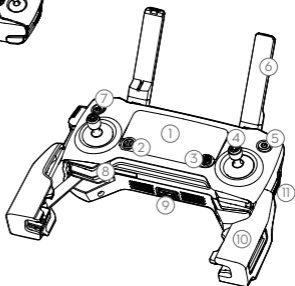

12. Gimbal Dial
13. Aperture/Shutter Adjustment Dial
14. Record Button
15. Focus/Shutter Button
16. Video-Downlink/Power Port (micro USB)
17. C1 Button (Customizable)
18. C2 Button (Customizable)

* The remote controller is able to reach its maximum transmission distance (FCC) in a wide-open area with no electromagnetic interference at an altitude of about 400 ft (120 m).

The maximum runtime is tested in a laboratory environment. This value is for reference only.

1. Download the DJI GO 4 App and Watching Tutorial Videos

Search "DJI GO 4" in the App Store or Google Play or scan the QR code below to download the app on your mobile device.



DJI GO 4

Watch the tutorial videos at www.dji.com/mavic-2 or in DJI GO 4 by tapping the icon in the top right corner of your screen.



Tutorial videos



DJI GO 4 is compatible with iOS 9.0 (or later) or Android 4.4 (or later).

2. Preparing the Aircraft

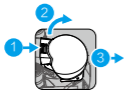

Remove the gimbal cover from the camera.



Unfold the front arms.



Unfold the rear arms.



Marked Unmarked

Match the propellers to motors.



Press the propellers down firmly and rotate in the lock direction.



Unfolded



Unfold the front arms and the propellers before the rear ones. All arms and propellers must be unfolded before takeoff.

3. Charging the Batteries

Use the provided charger to fully charge the Intelligent Flight Battery before first use.

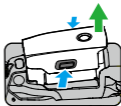

Remove the Intelligent Flight Battery

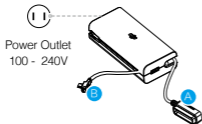

Power Outlet
100 - 240V



Charging Time:
~1 hour 30 minutes

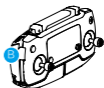

Charging Time:
~2 hour 15 minutes



Remove the remote controller cable before charging.

• Checking the Battery Levels and Powering On/Off

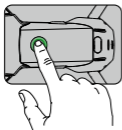

Press once to check the battery level.
Press, then press and hold to turn on/off.

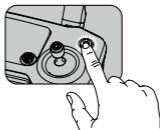

BAT 100 PCT

Press once to check the battery level on
the LCD screen.

Press once, then press and hold to turn on/
off the remote controller.

4. Preparing the Remote Controller

EN

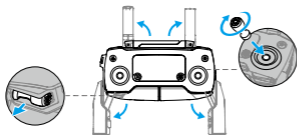

Unfold the antennas and mobile device clamps, then attach the control sticks.



Place one end of the RC cable to the end of the slot.

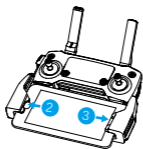

Attach your mobile device within the clamps.



Set the antennas parallel to each other

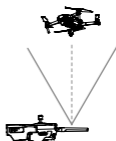
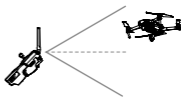

Optimal Transmission Range

- ⚠ Ensure the control sticks are firmly mounted.
- The remote controller cable with the Lightning connector is mounted by default. Use the appropriate cable for your mobile device to connect to the remote controller. When using an iPad or tablet, use the USB port on the remote controller.
- Do not use the Micro USB and the USB ports simultaneously for linking video.

5. Preparing for Takeoff



Power on the remote controller



Power on the aircraft



Launch DJI GO 4



Use your DJI account to activate the aircraft. Activation requires an internet connection.

6. Flight

Before taking off, make sure the Aircraft Status Bar in DJI GO 4 displays "Ready to Go".

Ready to Go (GPS)

• Auto Takeoff / Landing



Auto Takeoff



Auto Landing

• Manual Takeoff / Landing

Combination stick command to start/stop the motors



OR



Left stick up (slowly)
to take off



Left stick down (slowly) until you touch the ground
Hold a few seconds to stop the motors



The motors can only be stopped mid-flight when the flight controller detects critical error.

• Remote Controller Operation

The default flight control is known as Mode 2. The left stick controls the aircraft's altitude and heading, while the right stick controls its forward, backward, left and right movements. The gimbal dial controls the camera's tilt.

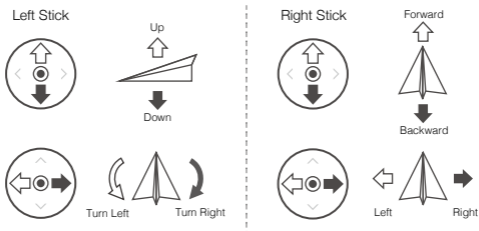

 Press the Flight Pause button for emergency braking during flight.

• In DJI GO 4

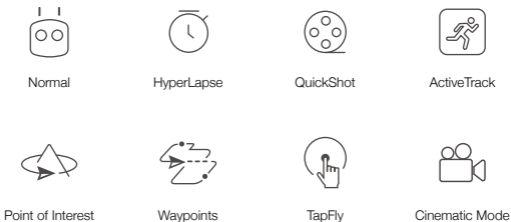

 • Watch the tutorials in DJI GO 4 or at the official DJI website to learn more.
• Always set an appropriate RTH altitude before takeoff. When the aircraft is returning to the Home Point, you should guide it with the control sticks.

7. Fly Safe



Fly in Open
Areas

+



Strong GPS
Signal

+



Maintain Line of
Sight

+



Fly Below 400 Feet
(120 m)



Avoid flying over or near obstacles, crowds, high voltage power lines, trees or bodies of water.

DO NOT fly near strong electromagnetic sources such as power lines and base stations as it may affect the onboard compass.



DO NOT use the aircraft in adverse weather conditions such as rain, snow, fog and wind speeds exceeding 10 m/s or 22 mph.



Stay away from the rotating propellers
and motors.



No Fly Zone

Learn more at:
<http://flysafe.dji.com/no-fly>



It's important to understand basic flight guidelines, for the safety of both you and those around you. Don't forget to read the *Disclaimer and Safety Guidelines*.

Specifications

• Aircraft

Weight	907 g
Max Speed	44.7 mph (72 kph) in Sport mode without wind
Max Service Ceiling Above Sea Level	19685 ft (6000 m)
Operating Temperature	14° to 104° F (-10° to 40° C)
GNSS	GPS + GLONASS
Operating Frequency	2.4-2.4835 GHz; 5.725-5.850 GHz
Transmitter Power (EIRP)	2.4 GHz FCC: ≤26 dBm; CE/MIC: ≤20 dBm; SRRC: ≤20 dBm 5.8 GHz FCC: ≤26 dBm; CE: ≤14 dBm; SRRC: ≤26 dBm

• Gimbal

Controllable Range	Pitch: -90° to +30°
--------------------	---------------------

• Camera

Sensor	1" CMOS; Effective pixels: 20M
Lens	FOV: approx. 77° 35 mm format equivalent: 28 mm Aperture: f/2.8-f/11 Focus: 1 m to ∞
ISO Range	Video: 100-6400 Photo: 100-3200 (auto); 100-12800 (manual)
Electronic Shutter Speed	8-1/8000 s
Max Image Size	5472×3648
Still Photography Modes	Single shot Burst shooting: 3/5 frames Auto Exposure Bracketing (AEB): 3/5 bracketed frames at 0.7 EV Bias Interval
Video Recording Modes	4K Ultra HD: 3840×2160 24/25/30p 2.7K: 2688×1512 24/25/30/48/50/60p FHD: 1920×1080 24/25/30/48/50/60/120p
Video Storage Bitrate	100 Mbps
Photo	JPEG, DNG (RAW)
Video	MP4, MOV (MPEG-4 AVC/H.264, HEVC)
Supported SD Cards	microSD Max Capacity: 128 GB (UHS-I Speed Grade 3 rating required)

• Remote Controller

Operating Frequency	2.4-2.4835 GHz; 5.725-5.850 GHz
Max Transmission Distance (Unobstructed and free of interference)	FCC: 5 mi (8 km); CE/MIC: 3.1 mi (5 km); SRRC: 3.1 mi (5 km)
Operating Temperature	32° to 104° F (0° to 40° C)
Battery	3950mAh @ 3.83V

Transmitter Power (EIRP)	2.4 GHz FCC: ≤26 dBm; CE/MIC: ≤20 dBm; SRRC: ≤20 dBm 5.8 GHz FCC: ≤26 dBm; CE: ≤14 dBm; SRRC: ≤26 dBm
Operating Voltage	1800mA @ 3.83V (when charging the mobile device)
Supported Mobile Device Size	Thickness supported: 6.5 - 8.5 mm, Max length: 160 mm Supported USB port types: Lightning, Micro USB (Type-B) USB-C
• Charger	
Voltage	17.6±0.1 V
Rated Power	60 W
• Intelligent Flight Battery	
Capacity	3850 mAh
Voltage	17.6 V (max) 15.4 V (typical)
Battery Type	LiPo 4S
Energy	59.29 Wh
Net Weight	Approx. 297 g
Charging Temperature Range	41° to 104° F (5° to 40° C)
Max Charging Power	80 W

For more information, read the User Manual:

<http://www.dji.com/mavic-2>

※ This content is subject to change without prior notice.

MAVIC is a trademark of DJI.

Copyright © 2018 DJI All Rights Reserved.

Designed by DJI. Printed in China.

Fluggerät

Die DJI™ MAVIC™ 2 Pro verfügt über Rundum-Sichtsysteme, Infrarotsensorsysteme* und einen voll stabilisierten 3-Achsen-Gimbal, dessen Kamera mit 1"-CMOS-Sensor (in Kooperation zwischen DJI und Hasselblad entwickelt) Videos in 4K und Fotos mit 20 Megapixeln aufnehmen kann. Mit exklusiven DJI Technologien wie der Hinderniserkennung sowie intelligenten Flugmodi wie Hyperlapse, ActiveTrack™ 2.0, QuickShot und Panorama oder auch fortschrittlichen Assistenzsystemen für den Piloten, gelangen selbst komplexe Aufnahmen mühelos. Die Mavic 2 Pro besticht durch eine maximale Fluggeschwindigkeit von 72 km/h und eine maximale Flugzeit** von 31 Minuten.

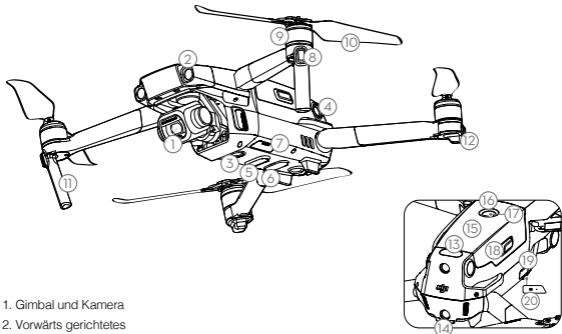

- | | | |
|--|--|---------------------------------------|
| 1. Gimbal und Kamera | 10. Propeller | 16. Akkuladestatus-LED |
| 2. Vorwärts gerichtetes Sichtsystem | 11. Antennen | 17. Ein/Aus-Taste |
| 3. Abwärts gerichtetes Sichtsystem | 12. Statusanzeige des Fluggeräts | 18. Batterieklammern |
| 4. Seitliches Sichtsystem | 13. Nach oben gerichtete Infraroterkennung | 19. USB-C-Anschluss |
| 5. Nach unten gerichtetes Infrarotsensorsystem | 14. Rückwärts gerichtetes Sichtsystem | 20. Koppeltaste/ Koppplungsstatus-LED |
| 6. Hilfsbeleuchtung | 15. Intelligent Flight Battery | |
| 7. Einschub für die Micro-SD-Karte | | |
| 8. Vordere LEDs | | |
| 9. Motoren | | |

* Die Sicht- und Infrarotsensorsysteme reagieren empfindlich auf die Umgebungsbedingungen. Näheres erfahren Sie im Haftungsausschluss, in den Sicherheitsvorschriften, in der Bedienungsanleitung und in den Video-Tutorials in der DJI GO™ 4 App oder auf der offiziellen DJI-Website. <http://www.dji.com/mavic-2>

** Die maximale Flugzeit wurde ohne Wind und bei einer konstanten Geschwindigkeit von 25 km/h getestet. Dieser Wert dient nur als Referenz.

Fernsteuerung

In die Fernbedienung integriert ist DJIs Langstrecken-Übertragungstechnologie OCUSYNC™ 2.0, die eine maximale Übertragungsweite von 8 km und die Videoübertragung vom Fluggerät an die DJI GO 4 App auf Ihrem Mobilgerät mit bis zu 1080p ermöglicht. Das integrierte LCD-Display liefert in Echtzeit wichtige Informationen zum Fluggerät, und die abnehmbaren Steuerknüppel erleichtern das Verstauen. Maximale Betriebszeit: 2 Std. und 15 Minuten*



Zusammengeklappt

1. LCD-Bildschirm
2. Flugpausentaste
3. 5D-Taste
4. Abnehmbare Steuerknüppel
5. Ein/Aus-Taste
6. Antennen
7. Rückkehrtaste
8. Staufach für Steuerknüppel
9. USB-Anschluss (Assistant Video-Downlink)
10. Mobilgeräteklammer
11. Flugmoduswechsler
12. Gimbal-Rädchen

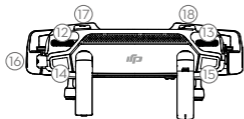
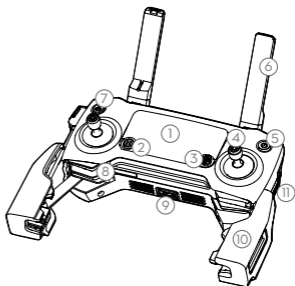

13. Einstellrädchen für Blende/
Verschlusszeit
14. Videotaste
15. Taste für Fokus/Verschluss
16. Video-Downlink-/Lade-Anschluss
(Micro-USB)
17. C1-Taste (frei belegbar)
18. C2-Taste (frei belegbar)

* Die Fernsteuerung erreicht ihre maximale Übertragungsreichweite (FCC) auf offenem Gelände ohne elektromagnetische Störquellen bei einer Flughöhe von ca. 120 m.

Die maximale Laufzeit wurde unter Laborbedingungen getestet. Dieser Wert dient nur als Referenz.

1. Die DJI GO 4 App herunterladen und Video-Tutorials ansehen

Suchen Sie im App Store oder auf Google Play nach „DJI GO 4“ oder scannen Sie den QR-Code, um die App auf Ihr Mobilgerät herunterzuladen.



DJI GO 4

Sehen Sie sich die Video-Tutorials auf www.dji.com/mavic-2 oder in der DJI GO 4 App durch Tippen auf das Symbol in der oberen rechten Ecke des Bildschirms an.



Video-Tutorials



DJI GO 4 ist mit iOS 9.0 (oder höher) sowie Android 4.4 (oder höher) kompatibel.

2. Fluggerät vorbereiten

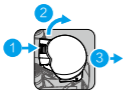

Entfernen Sie die Gimbal-Abdeckung von der Kamera.



Klappen Sie die vorderen Arme aus.



Klappen Sie die hinteren Arme aus.



Markiert Nicht markiert

Ordnen Sie die Propeller den richtigen Motoren zu.



Drücken Sie die Propeller herunter, und drehen Sie sie in die Verriegelungsrichtung.



Ausgeklappt



Klappen Sie die vorderen Arme und die Propeller aus, bevor Sie die hinteren Arme ausklappen. Vor dem Losfliegen müssen alle Arme und Propeller ausgeklappt sein.

3. Die Akkus laden

Verwenden Sie das im Lieferumfang enthaltene Ladegerät, um die Intelligent Flight Battery vor der ersten Verwendung vollständig aufzuladen.

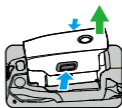

Intelligent Flight Battery entnehmen.

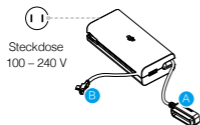

Steckdose
100 – 240 V



Ladezeit:
ca. 1 Std. 30 Minuten

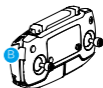

Ladezeit:
ca. 2 Std. 15 Minuten



Das Fernsteuerungskabel muss vor dem Aufladen entfernt werden.

* Ladezustand prüfen und Ein/Ausschalten

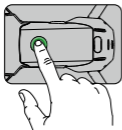

Drücken Sie die Taste einmal, um den Akku-Ladezustand zu überprüfen.
Drücken Sie die Taste einmal kurz und dann lang, um das Gerät ein-/auszuschalten.

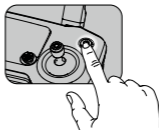

BAT 100 PCT

Drücken Sie die Taste einmal, um den Akkuladezustand auf dem LCD-Display zu überprüfen.

Drücken Sie die Taste noch einmal, und halten Sie sie gedrückt, um die Fernsteuerung ein-/auszuschalten.

4. Fernsteuerung vorbereiten

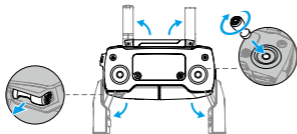

Klappen Sie die Antennen und die Mobilgeräteklammern auf, und montieren Sie die Steuerknüppel.



Stecken Sie ein Ende des RC-Kabels in das Ende des Schlitzes.

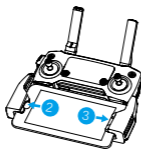

Sichern Sie Ihr Mobilgerät mit den Klammern.



Stellen Sie die Antennen parallel zueinander ein

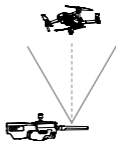
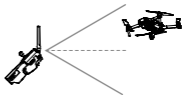

Optimaler Sendebereich

- Stellen Sie sicher, dass die Steuerknüppel fest montiert sind.
- Das Fernsteuerungskabel mit dem Lightning-Anschluss ist standardmäßig montiert. Verwenden Sie zur Verbindung mit der Fernsteuerung das richtige Kabel für Ihr Mobilgerät. Wenn Sie ein iPad oder Tablet verwenden, nutzen Sie den USB-Anschluss der Fernsteuerung.
- Verwenden Sie die Micro-USB- und USB-Anschlüsse nie gleichzeitig für die Videoverbindung.

5. Vorbereitung für den Start



Fernsteuerung einschalten



Fluggerät einschalten



DJI GO 4 starten



Internet

Verwenden Sie Ihr DJI-Konto, um das Fluggerät zu aktivieren. Für die Aktivierung wird eine Internetverbindung benötigt.

6. Flug

Vergewissern Sie sich vor dem Losfliegen, dass die Statusleiste in DJI GO 4 „Bereit“ anzeigt.

Ready to Go (GPS)

• Automatisches Starten/Landen



Automatisches Starten



Automatisches Landen

• Automatisches Starten/Landen

Knüppelkombination zum Ein-/
Ausschalten der Motoren



ODER



Linken Knüppel langsam
nach oben bewegen,
um zu starten



Drücken Sie den linken Knüppel nach unten
(langsam), bis das Fluggerät den Boden berührt.
Einige Sekunden halten, um die Motoren
auszuschalten



Die Motoren können während des Fluges nur gestoppt werden, wenn der Flugcontroller einen kritischen Fehler erkennt.

• Die Fernsteuerung verwenden

Die Standard-Flugsteuerung wird als Modus 2 bezeichnet. Mit dem linken Steuerknüppel steuern Sie die Höhe und Flugrichtung des Fluggeräts, und mit dem rechten Steuerknüppel steuern Sie ihre Vorwärts-, Rückwärts-, Links- oder Rechtsbewegung. Mit dem Gimbal-Rädchen wird die Neigung der Kamera verstellt.

Linker Knüppel



Rechter Knüppel



Drücken Sie die Taste „Flugpausentaste“ zur Notbremsung während des Fluges.

• In DJI GO 4



Normal



Bewegter Zeitraffer



QuickShot



ActiveTrack



Point of Interest



Wegpunkte



TapFly



Cinematic



- Näheres erfahren Sie in den Tutorials in der DJI GO 4 App oder auf der offiziellen DJI-Website.
- Stellen Sie vor jedem Start immer eine geeignete Höhe für die Rückkehrfunktion ein. Wenn das Fluggerät zum Startpunkt zurückkehrt, sollten Sie es mit den Steuerknüppeln korrigieren, falls nötig.

7. Sicher fliegen



Nur in offenen
Bereichen fliegen

+



Starkes
GPS-Signal

+



Sichtkontakt
behalten

+



Fliegen Sie unterhalb
von 120 m.



Über- und umfliegen Sie Hindernisse, Menschenmengen, Hochspannungsleitungen, Bäume und Gewässer stets mit ausreichendem Sicherheitsabstand.

Fliegen Sie NICHT in die Nähe elektromagnetischer Quellen (z. B. Hochspannungsleitungen, Basisstationen), da die Funktion des Bordkompasses dadurch gestört werden kann.



≥ 10 m/s

Fliegen Sie NICHT bei widrigem Wetter (z. B. Regen, Schnee, Nebel oder Windgeschwindigkeiten über 10 m/s).



Halten Sie ausreichend Abstand zu den
drehenden Propellern und Motoren.



Flugverbotszonen
(GEO-Zone)

Mehr Informationen:
<http://flysafe.dji.com/no-fly>



Um Ihre eigene Sicherheit und die Sicherheit der Menschen in Ihrer Umgebung zu gewährleisten, ist es wichtig, dass Sie die nötigen Grundregeln kennen. Lesen Sie sich den **Haftungsausschluss und die Sicherheitsvorschriften** durch..

Technische Daten

• Fluggerät

Gewicht	907 g
Max. Fluggeschwindigkeit	72 km/h im Sportmodus ohne Wind
Max. Dienstgipfelhöhe über N.N.	6.000 m
Betriebstemperatur	-10° bis 40 °C
GNSS	GPS + GLONASS
Betriebsfrequenz	2,4-2,4835 GHz; 5,725-5,850 GHz
Sendeleistung (EIRP)	2,4 GHz FCC: ≤26 dBm; CE/MIC: ≤ 20 dBm; SRRC: ≤20 dBm 5,8 GHz FCC: ≤26 dBm; CE: ≤14 dBm; SRRC: ≤26 dBm

• Gimbal

Kontrollierter Bereich	Nickachse: -90° bis +30°
------------------------	--------------------------

• Kamera

Sensor	1"-CMOS, tatsächliche Pixelanzahl: 20M
Objektiv	FOV: ca. 77° entspricht 35-mm-Format: 28 mm Blendenzahl: f/2.8 – f/11 Fokus: 1 m bis ∞
ISO-Bereich	Video: 100 – 6400 Fotos: 100 – 3200 (Auto); 100 – 12800 (manuell)
Belichtungszeit	8 – 1/8000 s
Max. Bildgröße	5472×3648
Fotomodi	Einzelaufnahme Serienbildaufnahme: 3/5 Bilder Belichtungsreihe: 3/5 fokussierte Frames bei Blendenöffnung 0,7 Intervall
Videoaufnahmemodi	4K Ultra HD: 3840×2160 24/25/30p 2.7K: 2688×1512 24/25/30/48/50/60p FHD: 1920×1080 24/25/30/48/50/60/120p
Bitrate des Videospeichers	100 Mb/s
Foto	JPEG, DNG (RAW)
Video	MP4, MOV (MPEG-4 AVC/H.264, HEVC)
Unterstützte SD-Speicherkarten	microSD Max. Speicherkapazität: 128 GB (UHS-I Geschwindigkeitsklasse 3 benötigt)

• Fernsteuerung

Betriebsfrequenz	2,4-2,4835 GHz; 5,725-5,850 GHz
Sendereichweite (bei direkter Sichtverbindung und ohne Störungen)	FCC: 8 km; CE/MIC: 5 km; SRRC: 5 km
Betriebstemperatur	0 bis 40 °C
Akku	3950 mAh bei 3,83 V

Sendeleistung (EIRP)	2,4 GHz FCC: ≤ 26 dBm; CE/MIC: ≤ 20 dBm; SRRC: ≤ 20 dBm 5,8 GHz FCC: ≤ 26 dBm; CE: ≤ 14 dBm; SRRC: ≤ 26 dBm
Betriebsspannung	1800 mA bei 3,83 V (beim Laden des Mobilgeräts)
Unterstützte Mobilgerätegröße	Unterstützte Dicke 6,5...8,5 mm, max. Länge: 160 mm Unterstützte USB-Porttypen Lightning, Micro-USB (Typ B) USB-C
• Ladegerät	
Spannung	17,6 \pm 0,1 V
Nennleistung	60 W
• Intelligent Flight Battery	
Kapazität	3850 mAh
Spannung	17,6 V (max.) 15,4 V (normal)
Akkutyp	LiPo 4S
Energie	59,29 Wh
Nettogewicht	ca. 297 g
Ladetemperatur	5 bis 40 °C
Max. Ladeleistung	80 W

Nähere Informationen finden Sie in der Bedienungsanleitung:
<http://www.dji.com/mavic-2>

※ Der Inhalt kann jederzeit unangekündigt geändert werden.

MAVIC ist eine Marke von DJI.
 Copyright © 2018 DJI Alle Rechte vorbehalten.

Gestaltung: DJI. Gedruckt in China.

Aeronave

La aeronave DJI™ MAVIC™ 2 Pro cuenta con un sistema de visión omnidireccional y un sistema de detección por infrarrojos*, así como una cámara con estabilizador en 3 ejes y un sensor CMOS de 1" (desarrollada de forma conjunta entre DJI y Hasselblad) que permite grabar vídeo 4K y hacer fotos de 20 megapíxeles. Las tecnologías de la firma DJI, como el sistema de detección de obstáculos y los Modos de Vuelo Inteligente (Hyperlapse, ActiveTrack™ 2.0, QuickShot, Panorámica y Sistema avanzado de asistencia al piloto), facilitan la captura de fotos complejas. Mavic 2 Pro alcanza una velocidad de vuelo máxima de 72 km/h (44,7 mph) y un tiempo máximo de vuelo de 31 minutos**.

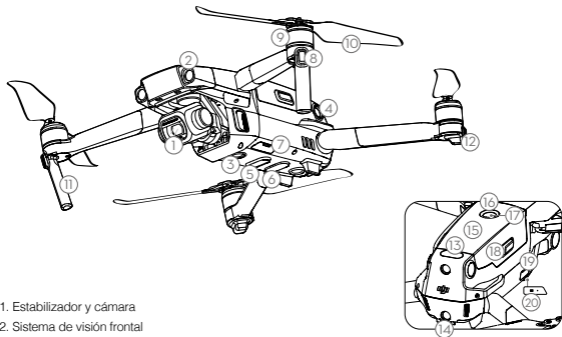

- | | | |
|--|---|---|
| 1. Estabilizador y cámara | 11. Antenas | 17. Botón de encendido |
| 2. Sistema de visión frontal | 12. Indicador de estado de la aeronave | 18. Bandas de sujeción de la batería |
| 3. Sistema de visión inferior | 13. Sistema de detección superior por infrarrojos | 19. Puerto USB-C |
| 4. Sistema de visión lateral | 14. Sistema de visión de retroceso | 20. Botón de vinculación/
indicador de estado de vinculación |
| 5. Sistema de detección inferior por infrarrojos | 15. Batería de Vuelo Inteligente | |
| 6. Luz inferior auxiliar | 16. Indicadores LED de nivel de batería | |
| 7. Ranura para tarjeta microSD | | |
| 8. Indicadores LED delanteros | | |
| 9. Motores | | |
| 10. Hélices | | |

* El sistema de visión y el sistema de detección por infrarrojos se ven afectados por las condiciones del entorno. Lea la renuncia de responsabilidad y las directrices de seguridad, el manual del usuario y vea los videotutoriales en la aplicación DJI GO™ 4 o en el sitio web oficial de DJI para obtener más información.
<http://www.dji.com/mavic-2>

** El tiempo máximo de vuelo se determinó en un entorno sin viento a una velocidad sostenida de 25 km/h (15,5 mph). Este valor se proporciona sólo como referencia.

Control remoto

El control remoto lleva incorporada la tecnología de transmisión de largo alcance de DJI, Ocusync™ 2.0, que ofrece un alcance de transmisión máximo de 8 km (5 millas) y permite visualizar vídeo de la aeronave en la aplicación DJI GO 4 de su dispositivo móvil en 1080p. La pantalla LCD integrada ofrece información sobre la aeronave en tiempo real, mientras que las palancas de control desmontables facilitan el almacenamiento del control remoto.

Tiempo de funcionamiento máximo: 2 hora y 15 minutos*



Plegado

1. Pantalla LCD
2. Botón de pausa durante vuelo
3. Botón 5D
4. Palancas de control extraíbles
5. Botón de encendido
6. Antenas
7. Botón RTH
8. Ranura de almacenamiento de las palancas de control
9. Puerto de transmisión de vídeo de reserva (USB)
10. Abrazadera para dispositivo móvil
11. Interruptor de modo de vuelo

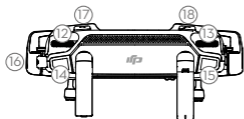
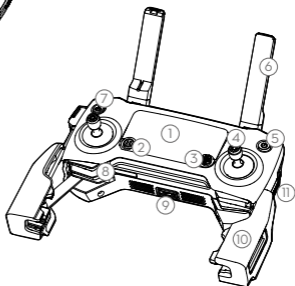

12. Dial del estabilizador
13. Dial de ajuste del obturador y la apertura
14. Botón de grabación
15. Obturador/botón de enfoque
16. Puerto de alimentación/transmisión de vídeo (microUSB)
17. Botón C1 (personalizable)
18. Botón C2 (personalizable)

* El control remoto es capaz de alcanzar su distancia máxima de transmisión (FCC) en una amplia zona abierta sin interferencias electromagnéticas y a una altitud de unos 120 metros (400 pies).

El tiempo de funcionamiento máximo se ha probado en un entorno de laboratorio. Este valor se proporciona sólo como referencia.

1. Descarga de la aplicación DJI GO 4 y visualización de los videotutoriales

Busque "DJI GO 4" en la App Store o en Google Play, o escanee el código QR siguiente para descargar la aplicación en su dispositivo móvil.



DJI GO 4

Vea los videotutoriales en www.dji.com/mavic-2 o en la aplicación DJI GO 4 tocando el icono en la esquina superior derecha de la pantalla.



Videotutoriales

 La aplicación DJI GO 4 es compatible con iOS 9.0 (o posterior) y Android 4.4 (o posterior).

2. Preparación de la aeronave

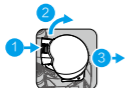

Retire la cubierta del estabilizador de la cámara.



Despliegue los brazos delanteros.



Despliegue los brazos traseros.



Con marca Sin marca
Empareje las hélices con los motores.



Presione las hélices hacia abajo firmemente y gírelas en la dirección de bloqueo.



Desplegado

 Despliegue los brazos y hélices frontales antes que los posteriores. Todos los brazos y hélices deben estar desplegados antes del despegue.

3. Carga de las baterías

Utilice el cargador suministrado para cargar completamente la Batería de Vuelo Inteligente antes del primer uso.

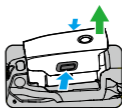

Extraiga la Batería de Vuelo Inteligente



Toma de alimentación
100 - 240 V



Tiempo de carga:
~1 hora y 30 minutos

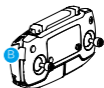

Tiempo de carga:
~2 horas y 15 minutos

 Retire el cable del control remoto antes de cargar.

• Comprobar los niveles de batería y encendido/apagado

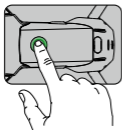

Pulse una vez para comprobar el nivel de batería.
Pulse una vez, después otra y mantenga pulsado para encender o apagar.

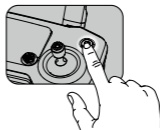

BAT 100 PCT

Pulse una vez para comprobar el nivel de batería en la pantalla LCD.
Pulse una vez, después otra y mantenga pulsado para encender o apagar el control remoto.

4. Preparación del controlador remoto

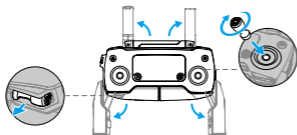

Despliegue las antenas, las abrazaderas del dispositivo móvil y fije las palancas de control.



Coloque un extremo del cable de RC en el extremo de la ranura.

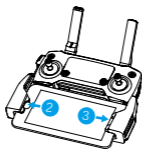

Acople el dispositivo móvil dentro de las abrazaderas.



Coloque las antenas paralelas entre sí.

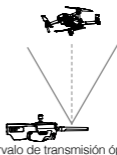
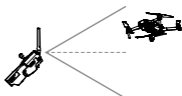

Intervalo de transmisión óptimo



- Compruebe que las palancas de control estén bien montadas.
- El cable del control remoto con el conector Lightning viene montado de forma predeterminada. Utilice el cable adecuado para conectar el dispositivo móvil al control remoto. Si utiliza un iPad o una tableta, utilice el puerto USB del control remoto.
- No utilice el cable micro USB ni los puertos USB de forma simultánea para conectar vídeo.

5. Preparación para el despegue



Encienda el controlador remoto.



Encienda la aeronave.



Inicie DJI GO 4.



Utilice su cuenta DJI para activar la aeronave. La activación requiere conexión a Internet.

6. Vuelo

Antes de despegar, asegúrese de que la barra de estado de la aeronave en la aplicación DJI GO 4 muestre "Ready to Go".

Ready to Go (GPS)

• Despegue/aterrizaje automáticos



Despegue automático



Aterrizaje automático

• Despegue/aterrizaje manuales

Comando de combinación de palancas para arrancar/detener los motores



O bien



Palanca izquierda arriba (espacio) para despegar



Palanca izquierda abajo (espacio) hasta tocar suelo
Mantenga unos segundos para detener los motores



Los motores sólo se pueden detener en pleno vuelo cuando el controlador de vuelo detecta un error crítico.

* Funcionamiento del control remoto

El control de vuelo predeterminado se conoce como Modo 2. La palanca izquierda controla la altitud y la dirección de la aeronave, mientras que la derecha controla los movimientos hacia delante, atrás, izquierda y derecha. El selector del estabilizador controla la inclinación de la cámara.

Palanca izquierda



Palanca derecha



Pulse el botón de pausa de vuelo para una frenada de emergencia durante el vuelo.

* En DJI GO 4



Normal



Hyperlapse



QuickShot



ActiveTrack



Punto de interés



Trayectoria



TapFly



Cinematográfico



- Vea los tutoriales en la aplicación DJI GO 4 o en el sitio web oficial de DJI para obtener más información.
- Establezca siempre una altitud de RTH (Regreso al punto de origen) adecuada antes del despegue. Cuando la aeronave esté volviendo al punto de origen, debe guiarla con las palancas de control.

7. Vuelo seguro



Vuele en espacios abiertos

+



Señal fuerte de GPS

+



Mantenga una línea de visión directa

+



Vuele por debajo de 120 m (400 pies)



Evite volar por encima o cerca de obstáculos, multitudes, líneas de alta tensión, árboles o masas de agua.

NO vuele cerca de fuentes electromagnéticas, como tendidos eléctricos y estaciones base, ya que puede afectar a la brújula de a bordo.



NO utilice la aeronave en condiciones climáticas adversas como lluvia, nieve, niebla ni con una velocidad del viento superior a 10 m/s o 22 mph.



Manténgase alejado de las hélices y los motores en rotación.



Zona GEO

Obtenga más información en:
<http://fllysafe.dji.com/no-fly>



Es importante conocer las directrices básicas de vuelo para su propia seguridad y la de quienes le rodean. No olvide leer la **Renuncia de responsabilidad y las directrices de seguridad**.

Especificaciones

• Aeronave

Peso	907 g
Velocidad máxima	72 km/h (44,7 mph) en modo Sport sin viento
Altitud de servicio máxima por encima del nivel del mar	6000 m (19685 ft)
Temperatura de funcionamiento	-10 a 40 °C (14 a 104 °F)
GNSS	GPS + GLONASS
Frecuencia de funcionamiento	2,4-2,4835 GHz; 5,725-5,850 GHz
Potencia del transmisor (PIRE)	2,4 GHz FCC: ≤ 26 dBm; CE/MIC: ≤ 20 dBm; SRRC: ≤ 20 dBm 5,8 GHz FCC: ≤ 26 dBm; CE: ≤ 14 dBm; SRRC: ≤ 26 dBm

• Estabilizador

Intervalo controlable	Cabeceo: -90° a +30°
-----------------------	----------------------

• Cámara

Sensor	CMOS de 1"; píxeles efectivos: 20 M
Objetivo	FOV: approx. 77° Equivalente a formato de 35 mm: 28 mm Apertura: f/2,8-f/11 Enfoque: 1 m a ∞
Intervalo de ISO	Video: 100-6400 Fotografía: 100-3200 (automático); 100-12800 (manual)
Velocidad de obturador electrónico	8-1/8000 s
Tamaño de imagen máximo	5472x3648
Modos de fotografía fija	Disparo simple Disparo en ráfagas: 3/5 fotogramas Exposición automática en horquillado (AEB): 3/5 fotogramas horquillados con sesgo de 0,7 EV Intervalo
Modos de grabación de vídeo	4K Ultra HD: 3840x2160 24/25/30p 2,7K: 2688x1512 24/25/30/48/50/60p FHD: 1920x1080 24/25/30/48/50/60/120p
Tasa de bits de almacenamiento de vídeo	100 Mbps
Fotografía	JPEG, DNG (RAW)
Vídeo	MP4, MOV (MPEG-4 AVC/H.264, HEVC)
Tarjetas SD admitidas	microSD Capacidad máxima: 128 GB (se necesita clasificación de velocidad clase 3 o UHS-I)

• Control remoto

Frecuencia de funcionamiento	2,4-2,4835 GHz; 5,725-5,850 GHz
Distancia de transmisión máx. (Sin obstáculos y sin interferencias)	FCC: 8 km (5 mi); CE/MIC: 5 km (3,1 mi); SRRC: 5 km (3,1 mi)
Temperatura de funcionamiento	De 0 °C a 40 °C (de 32 °F a 104 °F)

Batería	3950 mAh a 3,83 V
Potencia de transmisión (PIRE)	2,4 GHz FCC: ≤ 26 dBm; CE/MIC: ≤ 20 dBm; SRRC: ≤ 20 dBm 5,8 GHz FCC: ≤ 26 dBm; CE: ≤ 14 dBm; SRRC: ≤ 26 dBm
Voltaje de funcionamiento	1800 mA a 3,83V (al cargar el dispositivo móvil)
Tamaño admitido de dispositivo móvil	Espesor admitido: 6,5-8,5 mm, longitud máxima: 160 mm Tipos de puerto USB compatibles: Lightning, Micro USB (tipo B) USB-C
* Cargador	
Voltaje	17,6±0,1 V
Potencia nominal	60 W
* Batería de Vuelo Inteligente	
Capacidad	3850 mAh
Voltaje	17,6 V (máx.) 15,4 V (típico)
Tipo de batería	LiPo 4S
Energía	59,29 Wh
Peso neto	Aprox. 297 g
Intervalo de temperatura de carga	De 5 °C a 40 °C (de 41 °F a 104 °F)
Potencia de carga máx.	80 W

Para obtener más información, lea el manual del usuario:
<http://www.dji.com/mavic-2>

※ Este contenido puede modificarse sin notificación previa.

MAVIC es una marca comercial de DJI.
Copyright © 2018 DJI Todos los derechos reservados.

Diseñado por DJI. Impreso en China.

Appareil

Le DJI™ MAVIC™ 2 Pro est doté de systèmes optiques omnidirectionnels, de systèmes de détection infrarouge* et d'une caméra fixée sur une nacelle parfaitement stable à 3 axes avec un capteur CMOS de 1" (développé conjointement par DJI et Hasselblad), capable d'enregistrer des vidéos 4K et de prendre des photos d'une résolution de 20 mégapixels. Les technologies DJI comme la détection d'obstacles et les modes de vol intelligent (HyperLapse, ActiveTrack™ 2.0, QuickShot, Panorama, système d'assistance avancée au pilote) vous aident à réaliser des prises de vues complexes en toute simplicité. Le Mavic 2 Pro peut se targuer d'une vitesse de vol maximale de 72 km/h (44,7 mph) et d'un temps de vol maximum de 31 minutes**.

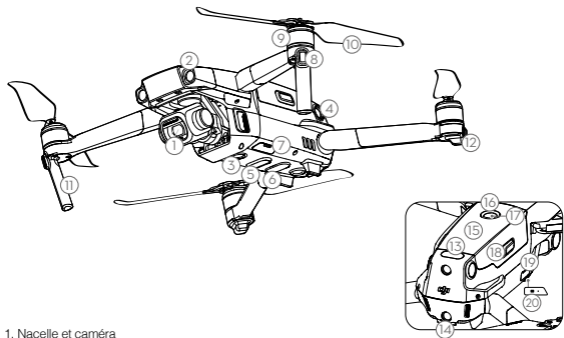

- | | | |
|--|--|--|
| 1. Nacelle et caméra | | |
| 2. Système optique avant | | |
| 3. Système optique inférieur | | |
| 4. Système optique latéral | | |
| 5. Système de détection infrarouge vers le bas | | |
| 6. Lampe inférieure | | |
| 7. Logement de la carte microSD | | |
| 8. LED avant | | |
| 9. Moteurs | | |
| | 10. Hélices | |
| | 11. Antennes | |
| | 12. Voyant d'état de l'appareil | |
| | 13. Système de détection infrarouge vers le haut | |
| | 14. Système optique arrière | |
| | 15. Batterie de Vol Intelligente | |
| | 16. Indicateurs de niveau de batterie | |
| | | 17. Bouton d'alimentation |
| | | 18. Bouton presseur de la batterie |
| | | 19. Port USB-C |
| | | 20. Bouton d'appairage/voyant d'état d'appairage |

* Les systèmes infrarouge et de vision sont influencés par les conditions environnantes. Pour en savoir plus, lisez la clause d'exclusion de responsabilité, les consignes de sécurité, ainsi que le guide de l'utilisateur, et visionnez les didacticiels vidéo dans l'application DJI GO™ 4 ou sur le site Web officiel de DJI. <http://www.dji.com/mavic-2>

** Le temps de vol maximum a été testé en l'absence de vent, à une vitesse constante de 25 km/h (15,5 mph). Cette valeur est fournie à titre indicatif uniquement.

Radiocommande

Intégrée à la radiocommande, la technologie de transmission à longue portée OCUSYNC™ 2.0 de DJI offre une portée de transmission maximale de 8 km (5 mi) et permet de transmettre des vidéos de l'appareil vers l'application DJI GO 4 installée sur votre appareil mobile en 1080p. Un écran LCD embarqué affiche en temps réel les données de l'appareil tandis que les manches de contrôle amovibles facilitent le rangement de la radiocommande.

Temps de fonctionnement maximal : 2 heures et 15 minutes*



1. Écran LCD
2. Bouton Pause de la fonction Vol
3. Bouton 5D
4. Manches de contrôle amovibles
5. Bouton d'alimentation
6. Antennes
7. Bouton RTH
8. Emplacement de rangement des manches de contrôle
9. Port Video-Downlink (USB) de réserve
10. Bride de fixation pour appareil mobile
11. Commutateur de mode de vol

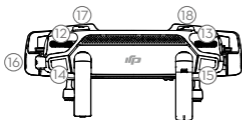
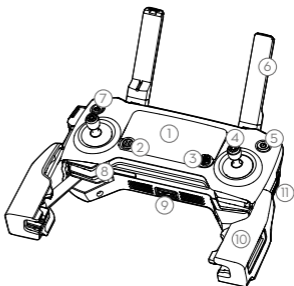

12. Molette de la nacelle
13. Molette de réglage ouverture/obturation
14. Bouton d'enregistrement
15. Bouton de mise au point/d'obturbateur
16. Port d'alimentation/Video-Downlink (micro USB)
17. Bouton C1 (personnalisable)
18. Bouton C2 (personnalisable)

* La radiocommande peut atteindre une distance de transmission maximale (FCC) dans une zone dégagée sans interférences électromagnétiques et à une altitude d'environ 120 mètres (400 pieds). Le temps d'exécution maximum a été testé dans un environnement de laboratoire. Cette valeur est fournie à titre indicatif uniquement.

1. Téléchargement de l'application DJI GO 4 et visionnage des didacticiels vidéo

Recherchez « DJI GO 4 » sur l'App Store ou sur Google Play, ou scannez le code QR ci-dessous pour télécharger l'application sur votre appareil mobile.



Application

Visionnez les didacticiels vidéo accessibles à l'adresse www.dji.com/mavic-2 ou dans DJI GO 4 en appuyant sur l'icône située dans le coin supérieur droit de votre écran.



Didacticiels vidéo

 DJI GO 4 est compatible avec iOS 9.0 (ou version ultérieure) ou Android 4.4 (ou version ultérieure).

2. Préparation de l'appareil

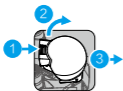

Retirez le cache de la nacelle de la caméra.



Dépliez les bras avant.



Dépliez les bras arrière.



Associez les hélices aux moteurs correspondants.



Montez solidement l'hélice, puis tournez dans la direction de verrouillage.



Déplié

 Dépliez les bras avant et les hélices avant ceux situés à l'arrière. Tous les bras et les hélices doivent être dépliés avant le décollage.

3. Chargement des batteries

Chargez entièrement la Batterie de Vol Intelligente à l'aide du chargeur fourni avant la première utilisation.

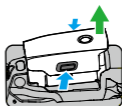

Retirez la Batterie de Vol Intelligente

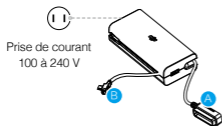

Prise de courant
100 à 240 V



Temps de charge :
environ 1 heure et
30 minutes

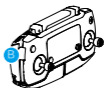

Temps de charge :
environ 2 heures et
15 minutes



Retirez le câble de la radiocommande avant de la charger.

*Vérification des niveaux de batterie et mise sous/hors tension

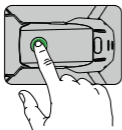

Appuyez une fois pour vérifier le niveau de la batterie.

Appuyez, puis maintenez enfoncé pour allumer/éteindre.

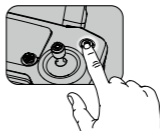

BAT 100 PCT

Appuyez une fois pour vérifier le niveau de batterie sur l'écran LCD.

Appuyez une fois, puis maintenez enfoncé pour allumer/éteindre la radiocommande.

4. Préparation de la radiocommande

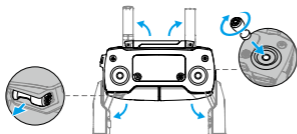

Dépliez les antennes et la bride de fixation pour appareil mobile, puis fixez les manches de contrôle.



Placez une extrémité du câble RC dans le logement.

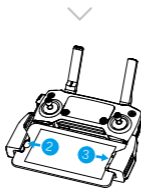

Fixez votre appareil mobile dans les brides de fixation.



Installez les antennes de façon parallèle l'une à l'autre

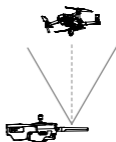
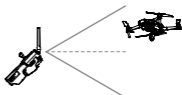

Plage de transmission optimale

- ⚠ Assurez-vous que les manches de contrôle sont bien en place.
- Le câble de la radiocommande doté du connecteur Lightning est monté par défaut. Utilisez le câble adapté à votre appareil mobile pour brancher ce dernier à la radiocommande. Avec un iPad ou une tablette, utilisez le port USB de la radiocommande.
- N'utilisez pas les ports USB et Micro-USB simultanément pour la liaison vidéo.

5. Préparation au décollage



Mettez la radiocommande sous tension



Mettez l'appareil sous tension



Lancez DJI GO 4



Utilisez votre compte DJI pour activer l'appareil. L'activation nécessite une connexion Internet.

6. Vol

Avant de procéder au décollage, vérifiez dans DJI GO 4 que la mention « Ready to Go » s'affiche dans la barre d'état de l'appareil.

Ready to Go (GPS)

• Décollage/atterrissage automatique



Décollage automatique



Atterrissage automatique

• Décollage/atterrissage manuel

Commande de manche combinée pour démarrer/couper les moteurs



OU



Relevez lentement le manche gauche pour décoller.



Abaissez lentement le manche gauche jusqu'à ce que l'appareil touche le sol. Maintenez la position pendant quelques secondes pour couper les moteurs.



Les moteurs peuvent être coupés en plein vol uniquement lorsque le contrôleur de vol détecte une erreur critique.

* Fonctionnement de la radiocommande

Le contrôle de vol par défaut est connu sous le nom de Mode 2. Le manche gauche agit sur l'altitude et l'orientation de l'appareil, tandis que le manche droit contrôle ses mouvements vers l'avant, l'arrière, la gauche et la droite. La molette de la nacelle contrôle l'inclinaison de la caméra.

Manche gauche

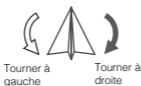

Manche droit



Appuyez sur le bouton Pause de la fonction Vol pour effectuer un freinage d'urgence en plein vol.

* Dans DJI GO 4



Normal



HyperLapse



QuickShot



ActiveTrack



Point of Interest



Waypoints



TapFly



Mode Cinéma



- Pour en savoir plus, visionnez les didacticiels dans DJI GO 4 ou sur le site Web officiel de DJI.
- Définissez toujours une altitude RTH appropriée avant le décollage. Lorsque l'appareil retourne au point de départ, guidez-le avec les manches de contrôle.

7. Voler en toute sécurité



Faire voler l'appareil dans des espaces ouverts

+



Signal GPS fort

+



Garder l'appareil en vue

+



Voler à moins de 120 m d'altitude (400 pieds)

FR



Évitez de faire voler l'appareil au-dessus ou à proximité d'obstacles, de rassemblements de personnes, de lignes électriques à haute tension, d'arbres ou d'étendues d'eau. Ne faites PAS voler l'appareil à proximité de sources électromagnétiques puissantes, telles que des lignes électriques ou des antennes relais. Celles-ci risquent en effet d'affecter le compas intégré.



N'utilisez PAS l'appareil dans de mauvaises conditions météorologiques (pluie, neige, brouillard, rafales dont la vitesse dépasse 10 m/s ou 35 km/h [22 mph], etc.).



Tenez-vous à distance des hélices et des moteurs en rotation.



Zone d'exclusion aérienne

Pour en savoir plus, rendez-vous sur le site : <http://flysafe.dji.com/no-fly>



Il est important que vous compreniez les consignes de vol fondamentales afin d'assurer votre sécurité et celle de votre entourage. N'oubliez pas de lire la *Clause d'exclusion de responsabilité et les consignes de sécurité*.

Caractéristiques techniques

• Appareil

Poids	907 g
Vitesse max.	72 km/h (44,7 mph) en mode Sport sans vent
Plafond pratique max. au-dessus du niveau de la mer	6 000 m (19 685 pieds)
Température de fonctionnement	-10 à 40° C (14 à 104° F)
GNSS	GPS + GLONASS
Fréquence de fonctionnement	2,4 à 2,4835 GHz ; 5,725 à 5,850 GHz
Puissance de l'émetteur (EIRP)	2,4 GHz FCC : ≤ 26 dBm ; CE/MIC : 20 dBm ; SRRC : ≤ 20 dBm 5,8 GHz FCC : ≤ 26 dBm ; CE : 14 dBm ; SRRC : ≤ 26 dBm

• Nacelle

Plage réglable	Angle vertical : -90 à +30°
----------------	-----------------------------

• Caméra

Capteur	CMOS 1" ; pixels effectifs : 20M
Objectif	Champ de vision : env. 77° équivalent 35 mm : 28 mm Ouverture : f/2.8-f/11 Mise au point : 1 m à ∞
Plage ISO	Vidéo : 100 à 6400 Photo : 100 à 3200 (Auto) ; 100 à 12800 (Manuel)
Vitesse d'obturation électronique	8 à 1/8000 s
Taille max. de l'image	5472 × 3648
Mode de photographie	Prise de vue unique Prise de vue en rafale : 3/5 clichés Bracketing d'exposition (AEB) : 3/5 clichés en bracketing à 0,7 EV Intervalle
Modes d'enregistrement vidéo	Ultra HD 4K : 3840 × 2160 24/25/30p 2,7K : 2688 × 1512 24/25/30/48/50/60p FHD : 1920 × 1080 24/25/30/48/50/60/120p
Bitrates de stockage vidéo	100 Mbit/s
Photo	JPEG, DNG (RAW)
Vidéo	MP4, MOV (MPEG-4 AVC/H.264, HEVC)
Cartes SD prises en charge	Micro SD Capacité max. : 128 Go (UHS-I Speed catégorie 3 requise)

• Radiocommande

Fréquence de fonctionnement	2,4 à 2,4835 GHz ; 5,725 à 5,850 GHz
Distance de transmission maximale (Sans obstacle gênant ni interférence)	FCC : 8 km (5 mi), CE/MIC : 5 km (3,1 mi) ; SRRC : 5 km (3,1 mi)
Température de fonctionnement	0 à 40 °C (32 à 104 °F)
Batterie	3 950 mAh à 3,83 V

Puissance de l'émetteur (EIRP)	2,4 GHz FCC : ≤ 26 dBm ; CE/MIC : 20 dBm ; SRRC : ≤ 20 dBm 5,8 GHz FCC : ≤ 26 dBm ; CE : 14 dBm ; SRRC : ≤ 26 dBm
Tension de fonctionnement	1 800 mA à 3,83 V (lors du chargement de l'appareil mobile)
Taille des appareils mobiles pris en charge	Épaisseur prise en charge : 6,5 à 8,5 mm, longueur maximale : 160 mm Types de port USB pris en charge : Lightning, Micro-USB (Type B) USB-C
• Chargeur	
Tension	17,6±0,1 V
Puissance nominale	60 W
• Batterie de Vol Intelligente	
Capacité	3 850 mAh
Tension	17,6 V (max.) 15,4 V (standard)
Type de batterie	LiPo 4S
Énergie	59,29 Wh
Poids net	Env. 297 g
Plage de température de chargement	5° à 40 °C (41° à 104 °F)
Puissance de charge max.	80 W

Pour en savoir plus, consultez le guide de l'utilisateur :
<http://www.dji.com/mavic-2>

※ Ce contenu peut être modifié sans préavis.

MAVIC est une marque commerciale de DJI.
 Copyright © 2018 DJI Tous droits réservés.

Une création de DJI. Imprimé en Chine.

Velivolo

Il modello DJI™ MAVIC™ 2 Pro è dotato di sistemi visivi omnidirezionali e sistemi di rilevamento a infrarossi*, inoltre ha un gimbal a 3 assi completamente stabilizzato con telecamera con sensore CMOS da 1" (sviluppato congiuntamente da DJI e Hasselblad); consente di girare video 4K e di scattare foto a 20 megapixel. Le tecnologie a marchio DJI, quali il rilevamento ostacoli e le modalità di volo intelligente (HyperLapse, ActiveTrack™ 2.0, QuickShot, Panorama e APAS), consentono di eseguire con facilità riprese e scatti complessi. Mavic 2 Pro vanta una velocità di volo massima di 72 km/h (44,7 mph) e un tempo di volo massimo** di 31 minuti.

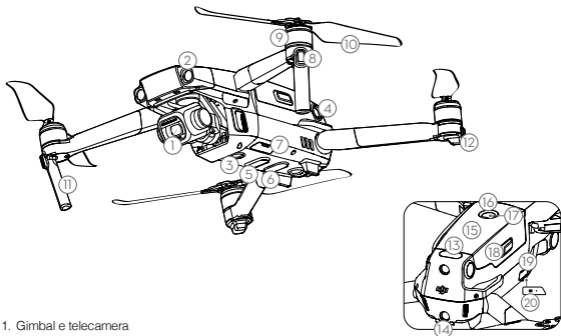

- | | | |
|---|--|--|
| 1. Gimbal e telecamera | 10. Eliche | 17. Pulsante di accensione |
| 2. Sistema visivo in avanti | 11. Antenne | 18. Fermi della batteria |
| 3. Sistema visivo verso il basso | 12. Indicatore di stato del velivolo | 19. Porta USB-C |
| 4. Sistema visivo laterale | 13. Sistema di rilevamento a infrarossi verso l'alto | 20. Pulsante di collegamento/ Indicatore di stato del collegamento |
| 5. Sistema di rilevamento a infrarossi verso il basso | 14. Sistema visivo all'indietro | |
| 6. Luce ausiliaria sulla parte inferiore | 15. Batteria di volo intelligente | |
| 7. Slot per scheda micro-SD | 16. LED di livello di carica della batteria | |
| 8. LED anteriori | | |
| 9. Motori | | |

* I sistemi visivi e i sistemi di rilevamento a infrarossi vengono influenzati dalle condizioni circostanti. Per saperne di più, leggere le Limitazioni di responsabilità e direttive sulla sicurezza e guardare i video tutorial nell'app DJI GO™ 4 o sul sito Web ufficiale DJI. <http://www.dji.com/mavic-2>

** Il tempo massimo di volo è stato testato in assenza di vento e a una velocità costante di 25 km/h (15,5 mph). Questo valore viene fornito soltanto come riferimento.

Dispositivo di controllo remoto

Nel dispositivo di controllo remoto è integrata la tecnologia di trasmissione a lungo raggio OCUSYNC™ 2.0 di DJI che offre un raggio massimo di trasmissione di 8 km (5 miglia) e che visualizza il video dal velivolo all'app DJI GO 4 sul dispositivo mobile dell'utente fino a 1080p. Lo schermo LCD di bordo fornisce le informazioni in tempo reale sui dati del velivolo, mentre le levette di comando rimovibili consentono un agevole stoccaggio del dispositivo di controllo remoto.

Durata massima di funzionamento: 2 ore e 15 minuti*



Ripiegato

1. Schermo LCD
2. Pulsante di messa in pausa del volo
3. Pulsante 5D
4. Levette di comando rimovibili
5. Pulsante di accensione
6. Antenne
7. Pulsante RTH
8. Alloggiamenti di stoccaggio delle levette di comando
9. Porta video-downlink di riserva (USB)
10. Supporto per dispositivo mobile
11. Commutatore della modalità di volo

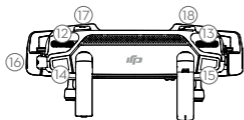
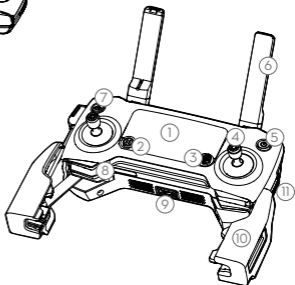

12. Selettore gimbal
13. Selettore di regolazione apertura/otturatore
14. Pulsante di registrazione
15. Pulsante di messa a fuoco/otturatore
16. Porta video-downlink/alimentazione (micro USB)
17. Pulsante C1 (personalizzabile)
18. Pulsante C2 (personalizzabile)

* Il dispositivo di controllo remoto è in grado di raggiungere la massima distanza di trasmissione (FCC) in una vasta area all'aperto priva di interferenze elettromagnetiche, a un'altitudine di circa 120 m (400 piedi).

Il runtime massimo è testato in ambiente di laboratorio. Questo valore viene fornito soltanto come riferimento.

1. Scaricare l'app DJI GO 4 e guardare i video tutorial

Cercare "DJI GO 4" nell'App Store o in Google Play, oppure effettuare la scansione del codice QR quid di seguito per scaricare l'app sul proprio dispositivo mobile.



DJI GO 4

Guardare i video dei tutorial all'indirizzo www.dji.com/mavic-2 o in DJI GO 4 toccando la relativa icona nell'angolo in alto a destra dello schermo.



Video tutorial

 DJI GO 4 è compatibile con iOS 9.0 (o versioni successive) o Android 4.4 (o versioni successive).

2. Preparazione del velivolo

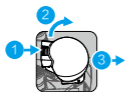

Rimuovere la protezione del gimbal dalla telecamera.



Dispiegare i bracci anteriori.



Dispiegare i bracci posteriori.



Contrassegnato Non contrassegnato

Far corrispondere le eliche ai motori



Premere con decisione le eliche verso il basso e ruotarle nella direzione di blocco.



Dispiegato

 Dispiegare i bracci e le eliche anteriori prima di quelli posteriori. Tutti i bracci e le eliche devono essere dispiegati prima del decollo.

3. Ricarica delle batterie

Utilizzare il caricabatterie in dotazione per caricare completamente la batteria di volo intelligente prima di utilizzarla per la prima volta.

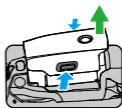

Rimuovere la batteria di volo intelligente



Tempo di carica:
~1 ora e 30 minuti

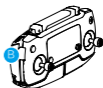

Tempo di carica:
~2 ore e 15 minuti



Rimuovere il cavo del dispositivo di controllo remoto prima di eseguire la ricarica.

* Controllo dei livelli della batteria e accensione/spengimento

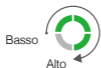

Premere una volta per verificare il livello di carica della batteria.
Premere e tenere premuto per accendere/spengere.

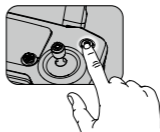

Premere una volta per verificare il livello di carica della batteria sullo schermo LCD.
Premere una volta, quindi premere e tenere premuto per accendere/spengere il dispositivo di controllo remoto.

4. Preparazione del dispositivo di controllo remoto

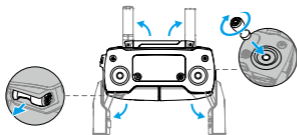

Dispiegare le antenne e le staffe del dispositivo mobile e fissare le levette di comando.



Posizionare una delle estremità del cavo RC all'estremità dell'alloggiamento.

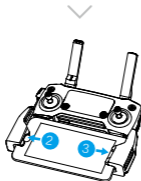

Inserire il dispositivo mobile all'interno delle staffe.



Sistemare le antenne in parallelo tra loro

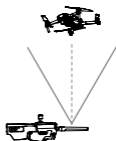

Raggio di trasmissione ottimale



- Accertarsi che le levette di comando siano montate saldamente.
- Il cavo del dispositivo di controllo remoto con il connettore Lightning è montato per impostazione predefinita. Utilizzare il cavo appropriato per il proprio dispositivo mobile per il collegamento del dispositivo di controllo remoto. Se si utilizza un iPad o un tablet, usare la porta USB sul dispositivo di controllo remoto.
- Non utilizzare la porta micro USB e la porta USB contemporaneamente per il collegamento video.

5. Preparazione al decollo



Accendere il dispositivo di controllo remoto



Accendere il velivolo



Lanciare l'app DJI GO 4



Utilizzare il proprio account DJI per attivare il velivolo. L'attivazione richiede una connessione Internet.

6. Volo

Prima del decollo, assicurarsi che la barra di stato del velivolo nell'app DJI GO 4 indichi "Ready to Go".

Ready to Go (GPS)

• Decollo e atterraggio automatici



Decollo automatico



Atterraggio automatico

• Decollo e atterraggio manuali

Combinazione di comandi da levette per avviare/arrestare i motori.



OPPURE



Portare la levetta sinistra (lentamente) verso l'alto per il decollo



Portare la levetta sinistra (lentamente) verso il basso finché non si tocca il suolo
Tenere premuto alcuni secondi per arrestare i motori



I motori possono essere spenti solo a metà volo, quando il sistema di controllo di volo rileva un errore critico.

* Funzionamento del dispositivo di controllo remoto

La modalità predefinita di controllo di volo è "Mode 2". La levetta sinistra controlla l'altitudine e la direzione del velivolo, mentre la levetta destra ne controlla i movimenti in avanti, all'indietro, a sinistra e a destra. Il quadrante del gimbal controlla l'inclinazione della telecamera.

Levetta sinistra



Levetta destra

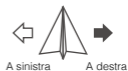

Premere il volo il pulsante Flight Pause per la frenata di emergenza durante il volo.

* DJI GO 4



Normal



HyperLapse



QuickShot



ActiveTrack



Point of Interest



Waypoint



TapFly



Modalità Cinematic



- Per ulteriori informazioni, guardare i video tutorial in DJI GO 4 sul sito Web ufficiale DJI.
- Impostare sempre un'altitudine RTH adeguata prima del decollo. Quando il velivolo sta tornando al punto iniziale, è consigliabile guidarlo con le levette di comando.

7. Fly Safe



Volare in zone aperte

+



Segnale GPS forte

+



Mantenere la linea di visione

+



Volare a un'altitudine inferiore a 120 m (400 piedi)



Evitare di volare al di sopra o in prossimità di ostacoli, folle, linee elettriche ad alta tensione, alberi e specchi d'acqua.

NON utilizzare il velivolo in prossimità di intense sorgenti elettromagnetiche quali linee elettriche e stazioni di base, in quanto tali sorgenti possono influenzare la bussola di bordo.



NON utilizzare il velivolo in condizioni meteorologiche avverse come pioggia, neve, nebbia e venti con velocità superiore a 10 m/s (22 mph).



Mantenere la distanza dalle eliche rotanti e dai motori.



Zona interdetta al volo

Per saperne di più:
<http://fllysafe.dji.com/no-fly>



Per la sicurezza propria e delle altre persone presenti nelle vicinanze, è importante comprendere le linee guida di base del volo. Ricordare di leggere le *Limitazioni di responsabilità e le direttive sulla sicurezza*.

Caratteristiche tecniche

• Velivolo

Peso	907 g
Velocità massima	72 km/h (44,7 mph) in modalità Sport in assenza di vento
Quota massima di funzionamento sopra il livello del mare	6.000 m (19.685 piedi)
Temperatura di funzionamento	Da -10 °C a 40 °C (da 14 °F a 104 °F)
GNSS	GPS + GLONASS
Frequenza di funzionamento	2,4-2,4835 GHz; 5,725-5,850 GHz
Potenza del trasmettitore (EIRP)	2,4 GHz FCC: ≤26 dBm; CE/MIC: ≤20 dBm; SRRC: ≤20 dBm 5,8 GHz FCC: ≤26 dBm; CE: ≤14 dBm; SRRC: ≤26 dBm

• Gimbal

Intervallo controllabile	Beccheggio: da -90° a +30°
--------------------------	----------------------------

• Telecamera

Sensore	CMOS da 1"; pixel effettivi: 20M
Oiettivo	FOV: circa 77° formato equivalente 35 mm: 28 mm Apertura: f/2,8-f/11 Messa a fuoco: 1 m a ∞
Intervallo ISO	Video: 100 - 6400 Foto: 100-3200 (auto), 100-12800 (manuale)
Velocità dell'otturatore elettronico	8-1/8000 s
Massima dimensione immagine	5.472x3.648
Modalità fotografia	Scatto singolo Scatti a raffica: 3/5 fotogrammi Auto Exposure Bracketing (AEB): 3/5 fotogrammi raggruppati a 0,7 EV bias Intervallo
Modalità di registrazione video	Ultra HD in 4K: 3840x2160 24/25/30p 2,7 K: 2688x1512 24/25/30/48/50/60p FHD: 1.920x1080 24/25/30/48/50/60/120p
Velocità di trasmissione per memorizzazione video	100 Mbps
Fotografie	JPEG, DNG (RAW)
Video	MP4, MOV (MPEG-4 AVC/H.264, HEVC)
Schede SD supportate	microSD Capacità massima: 128 GB (richiesto SpeedGrade 3 UHS-I)

• Dispositivo di controllo remoto

Frequenza di funzionamento	2,4-2,4835 GHz; 5,725-5,850 GHz
Distanza massima di trasmissione (senza ostacoli né interferenze)	FCC: 8 km (5 mi); CE/MIC: 5 km (3,1 mi); SRRC: 5 km (3,1 mi)
Temperatura di funzionamento	Da 0 °C a 40 °C (da 32 °F a 104 °F)
TB50-M200	3950 mAh a 3,83 V

Potenza del trasmettitore (EIRP)	2,4 GHz FCC: ≤26 dBm; CE/MIC: ≤20 dBm; SRRC: ≤20 dBm 5,8 GHz FCC: ≤26 dBm; CE: ≤14 dBm; SRRC: ≤26 dBm
Tensione di funzionamento	1800 mA a 3,83 V (durante la ricarica del dispositivo mobile)
Dimensioni del dispositivo mobile supportato	Spessore supportato: 6,5 - 8,5 mm, Lunghezza massima: 160 mm Tipi di porte USB compatibili: Lightning, Micro USB (Tipo B) USB-C
* Caricatore	
Tensione	17,6±0,1 V
Potenza nominale	60 W
* Batteria di volo intelligente	
Capacità	3850 mAh
Tensione	17,6 V (max) 15,4 V (tipico)
Tipo di batteria	LiPo 4S
Energia	59,29 Wh
Peso netto	Circa 297 g
Intervallo temperatura di carica	Da 5 °C a 40 °C (da 41 °F a 104 °F)
Massima potenza di carica	80 W

Per ulteriori informazioni, consultare il Manuale utente:
<http://www.dji.com/mavic-2>

※ Questi contenuti sono soggetti a modifiche senza preavviso.

MAVIC è un marchio registrato di DJI.
 Copyright © 2018 DJI Tutti i diritti riservati.

Progettato da DJI. Stampato in Cina.

Drone

De DJI™ MAVIC™ 2 Pro is uitgerust met omnidirectionele Vision Systems en infraroodsensorsystemen* en een volledig gestabiliseerde 3-assige gimbal met een 1" CMOS-sensorcamera (ontwikkeld in een samenwerking tussen DJI en Hasselblad) die 4K-video-opnamen en 20-megapixel-foto's maakt. De voor DJI zo kenmerkende technologieën zoals Obstacle Sensing (obstakels detecteren) en intelligente vluchtmodi zoals HyperLapse, ActiveTrack™ 2.0, QuickShot, Panorama, en Advanced Pilot Assistance Systems helpen je moeiteloos complexe opnamen te maken. De Mavic 2 Pro kan bogen op een maximale vliegsnelheid van 72 km/u (44,7 mph) en een maximale vliegduur** van 31 minuten.

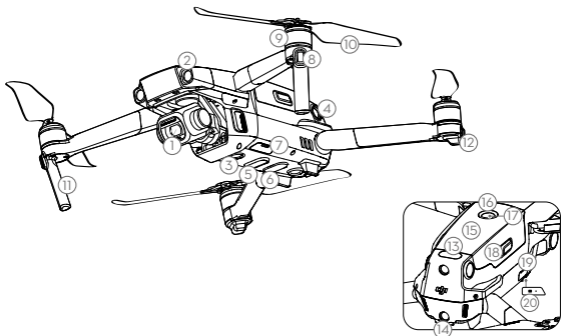

- | | | |
|--|---------------------------------|--|
| 1. Gimbal en camera | 10. Propellers | 16. Accuniveau-leds |
| 2. Vision System - naar voren | 11. Antennes | 17. Aan-/uitknop |
| 3. Vision System - naar beneden | 12. Statusindicator drone | 18. Accuaansluitingen |
| 4. Vision System - dwarsrichting | 13. Infraroodsensorsysteem | 19. USB-C-poort |
| 5. Naar beneden gericht infraroodsensorsysteem | 14. Vision System naar achteren | 20. Koppelhoets/koppelingstatusindicator |
| 6. Extra lampje onderaan | 15. Intelligent Flight Battery | |
| 7. microSD-kaartsleuf | | |
| 8. LED's voorzijde | | |
| 9. Motoren | | |

* Het Vision System en infraroodsensorsysteem worden beïnvloed door omgevingsomstandigheden. Lees de disclaimer en veiligheidsrichtlijnen en bekijk de rondleidingsvideo's in de DJI GO™ 4-app of op de officiële DJI-website voor meer informatie. <http://www.dji.com/mavic-2>

** De maximale vliegduur is getest bij omstandigheden zonder wind en met een constante snelheid van 25 km/u (25,5 mph). Deze waarde geldt alleen ter referentie.

Afstandsbediening

De lange-afstands-transmissietechnologie OCUSYNC™ 2.0 is geïntegreerd in de afstandsbediening van DJI, waardoor deze een maximaal zendbereik van 8 km (5 mijl) biedt en videostreaming van de drone naar de DJI GO 4-app op je mobiele apparaat weergeeft met tot wel 1080p. Een on-board-LCD-scherm biedt real-time-informatie over dronegegevens en door de verwijderbare joysticks kan de afstandsbediening eenvoudiger worden opgeborgen.

Maximale bedrijfstijd: 2 uur en 15 minuten*



Ingeklapt

1. LCD-scherm
2. Vluchtpauzeknop
3. 5D-knop
4. Verwijderbare joysticks
5. Aan-/uitknop
6. Antennes
7. RTH-knop
8. Opslagleuf joysticks
9. Reserve video-downlinkpoort (USB)
10. Klem mobiel apparaat
11. Vluchtmodusschakelaar

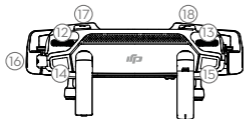
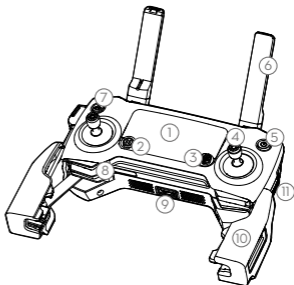

12. Gimbalwiel
13. Draaiknop instellingen sluiters/diafragma
14. Opnameknop
15. Scherpstellers-/opnameknop
16. Video-downlink/aan/uit-knop (micro-USB)
17. C1-knop (aanpasbaar)
18. C2-knop (aanpasbaar)

* De afstandsbediening kan de maximale overdrachtsafstand (FCC) bereiken in een grote open ruimte zonder elektromagnetische interferentie, en op een hoogte van circa 120 meter (400 ft).

De maximale looptijd is getest in een laboratorium. Deze waarde geldt alleen ter referentie.

1. Download de DJI GO 4-app en bekijk de filmpjes met uitleg

Zoek op 'DJI GO 4' in de App Store of Google Play, of scan de onderstaande QR-code om de app te downloaden op je mobiele apparaat.



DJI GO 4

Bekijk de filmpjes met uitleg op www.dji.com/mavic-2 of in DJI GO 4 door op het pictogram in de rechter bovenhoek van je scherm te klikken.



Filmpjes met uitleg



DJI GO 4 wordt ondersteund door iOS 9.0 (of hoger) of Android 4.4 (of hoger).

2. Drone voorbereiden

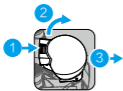

Verwijder de gimbal-afdekking van de camera.



Klap de voorarmen uit.



Klap de achterarmen uit.



Gemarkeerd Ongemarkeerd
Combineer de juiste propellers met de motoren.



Druk de propellers stevig naar beneden en draai ze in de vergrendelde stand.



Uitgeklaapt



Klap de voorarmen en de propellers uit vóór de achterste. Alle armen en propellers moeten uitgeklaapt zijn voordat mag worden opgestegen.

3. De accu's opladen

Gebruik de meegeleverde oplader om de Intelligent Battery volledig op te laden vóór het eerste gebruik.

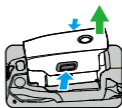

De Intelligent Flight Battery verwijderen

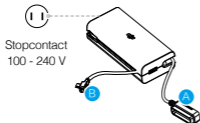

Stopcontact
100 - 240 V



Oplaadtijd:
~1 uur en 30 minuten

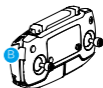

Oplaadtijd:
~2 uur en 15 minuten



Verwijder vóór het laden de kabel van de afstandsbediening.

* Controleer het laadniveau van de accu en de aan/uit-schakelaar

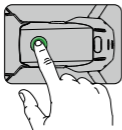

Druk eenmaal op de knop om het accuniveau te controleren.

Druk eenmaal en druk vervolgens opnieuw en houd vast om aan/uit te zetten.

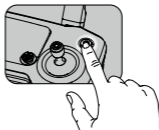

BAT 100 PCT

Druk eenmaal om het accuniveau op het LCD-scherm te controleren.

Druk eenmaal en druk vervolgens opnieuw en houd vast om de afstandsbediening aan/uit te zetten.

4. Voorbereiding van de afstandsbediening

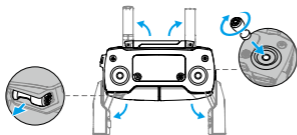

Klap de antennes en de klemmen van het mobiele apparaat uit en breng de joysticks aan.



Plaats één uiteinde van de RC-kabel op het sleufeinde.

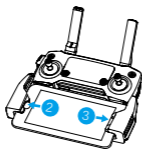

Plaats je mobiele apparaat in de klemmen.



Stel de antennes parallel aan elkaar af

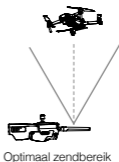
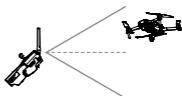

Optimaal zendbereik

- ⚠️ • Zorg dat de joysticks stevig zijn aangebracht.
- De kabel van de afstandsbediening met de Lightning Connector is standaard aangebracht. Gebruik de juiste kabel om je mobiele apparaat op de afstandsbediening aan te sluiten. Wanneer je een iPad of tablet gebruikt, gebruik dan de USB-poort op de afstandsbediening.
- Gebruik de micro-USB- en de USB-poorten tegelijkertijd om video te koppelen.

5. Voorbereiding voor opstijgen



Schakel de afstandsbediening in



Schakel het luchtvaartuig in



Start DJI GO 4



Gebruik je DJI-account om de drone te activeren. Activering vereist een internetverbinding.

6. Vlucht

Zorg er vóór het opstijgen voor dat de statusbalk van de drone in de DJI GO 4-app 'Ready to Go' aangeeft.

Ready to Go (GPS)

• Automatisch opstijgen/landen



Automatisch opstijgen



Automatisch landen

• Handmatig opstijgen/landen

Combination Stick Command (CSC) voor het starten/stoppen van de motoren



OF



Linkerstick omhoog (langzaam) om op te stijgen



Linkerjoystick omlaag (langzaam) totdat u de grond raakt
Wacht enkele seconden om de motoren uit te schakelen



De motoren kunnen gedurende de vlucht alleen worden stopgezet wanneer de vluchtcontroller een kritieke fout detecteert.

* Besturing met de afstandsbediening

De standaard vluchtregeling staat bekend als modus 2. Met de linkerjoystick regel je de hoogte en koers, terwijl je met de rechterjoystick vooruit, achteruit, naar links en rechts kunt bewegen. Met de gimbal regel je de kanteling van de camera.

Linkerjoystick



Omhoog



Omlaag



Linksaf

Rechtsaf

Rechterjoystick



Vooruit



Achteruit

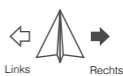

Links

Rechts



Druk op de Flight Pause-knop om tijdens de vlucht een noodstop uit te voeren.

* In DJI GO 4



Normaal



HyperLapse



QuickShot



ActiveTrack



Bezienswaardigheid
(POI)



Waypoints



TapFly



Cinemamodus



- Bekijk de filmpjes met uitleg in de DJI GO 4-app of op de officiële DJI-website voor meer informatie.
- Stel altijd een passende RTH-hoogte in vóór het opstijgen. Als het luchtvaartuig terugkeert naar de basis, dien je het te begeleiden met de joysticks.

7. Vlieg veilig



Vlieg in open gebieden



Krachtig GPS-signaal



Houd je drone in het zicht



Vlieg lager dan 120 m (400 feet)



Vermijd vliegen boven of nabij obstakels, drukte, hoogspanningsleidingen, bomen of water.

Vlieg NIET in de buurt van sterke elektromagnetische bronnen zoals elektriciteitsleidingen en basisstations, daardoor kan het ingebouwde kompas ongunstig worden beïnvloed.



Gebruik de drone NIET bij ongunstige weersomstandigheden zoals regen, sneeuw, mist en bij windsnelheden van meer dan 10 m/s of 22 mph.



Blijf uit de buurt van de roterende propellers en motoren.



No-fly zone

Meer informatie vind je op: <http://fllysafe.dji.com/no-fly>



Het is belangrijk de basisvluchtrichtlijnen te begrijpen voor je veiligheid en die van je medemens. Vergeet niet de **disclaimer en veiligheidsrichtlijnen te lezen**.

Specificaties

• Drone

Gewicht	907 g
Max. snelheid	72 km/u (44,7 mph) in de sportmodus zonder wind
Max. servicehoogte boven zeeniveau	6000 m (19.685 ft)
Bedrijfstemperatuur	-10 °C tot 40 °C (14 °F tot 104 °F)
GNSS	GPS + GLONASS
Bedrijfsfrequentie	2,4-2,4835 GHz; 5,725-5,850 GHz
Zendervermogen (EIRP)	2,4 GHz FCC: ≤ 26 dBm; CE/MIC: ≤ 20 dBm; SRRC: ≤ 20 dBm 5,8 GHz FCC: ≤ 26 dBm; CE: ≤ 14 dBm; SRRC: ≤ 26 dBm

• Gimbal

Regelbaar bereik	Helling: -90° tot +30°
------------------	------------------------

• Camera

Sensor	1-inch CMOS, effectieve pixels: 20M
Lens	FOV: ca. 77° 35 mm equivalent: 28 mm Diafragma: f/2,8-f/11 Focus: 1 m tot ∞
ISO-bereik	Video: 100-6400 Foto: 100-3200 (auto); 100-12800 (handmatig)
Elektronische sluitertijd	8-1/8000 s
Maximale beeldgrootte	5472x3648
Fotografie modi stilbeelden	Enkele opname Serieopnamen: 3/5 frames Auto Exposure Bracketing (AEB): 3/5 bracketed frames bij 0,7 EV Bias Interval
Video-opnamemodi	4K Ultra HD: 3840x2160 24/25/30p 2,7 K: 2688x1512 24/25/30/48/50/60p FHD: 1920x1080 24/25/30/48/50/60/120p
Bitrate video-opslag	100 Mbps
Foto	JPEG, DNG (RAW)
Video	MP4, MOV (MPEG-4 AVC/H.264, HEVC)
Ondersteunde SD-kaarten	microSD Max. capaciteit: 128 GB (UHS-I Speed Grade 3-rating vereist)

• Afstandsbediening

Bedrijfsfrequentie	2,4-2,4835 GHz; 5,725-5,850 GHz
Max. zendafstand (Vrij van obstakels en interferentie)	FCC: 8 km (5 mi); CE/MIC: 5 km (3,1 mi); SRRC: 5 km (3,1 mi)
Bedrijfstemperatuur	0 °C tot 40 °C (32 °F tot 104 °F)
Battery	3950 mAh bij 3,83 V

Zendervermogen (EIRP)	2,4 GHz FCC: ≤ 26 dBm; CE/MIC: ≤ 20 dBm; SRRC: ≤ 20 dBm 5,8 GHz FCC: ≤ 26 dBm; CE: ≤ 14 dBm; SRRC: ≤ 26 dBm
Bedrijfsspanning	1800 mAh bij 3,83 V (bij opladen van het mobiele apparaat)
Ondersteunde grootste mobiel apparaat	Ondersteunde dikte: 6,5 - 8,5 mm, Max. lengte: 160 mm Ondersteunde USB-poorttypen: Lightning, micro-USB (Type-B) USB-C
* Oplader	
Spanning	17,6±0,1 V
Nominaal vermogen	60 W
* Intelligent Flight Battery	
Capaciteit	3850 mAh
Spanning	17,6 V (max) 15.4 V (typisch)
Accutype	LiPo 4S
Vermogen	59.29 Wh
Netto gewicht	Ongeveer 297 g
Bereik oplaadtemperatuur	5 °C tot 40 °C (41 °F tot 104 °F)
Max. oplaadvermogen	80 W

Lees de gebruikershandleiding voor meer informatie:
<http://www.dji.com/mavic-2>

※ Deze inhoud is onderhevig aan wijzigingen zonder voorafgaande kennisgeving.

MAVIC is een handelsmerk van DJI.
Copyright © 2018 DJI Alle rechten voorbehouden.

Ontworpen door DJI. Gedrukt in China.

Aeronave

O DJI™ MAVIC™ 2 Pro dispõe de sistemas de visão omnidirecional e sistemas de detecção de infravermelhos*, além de uma suspensão cardã de 3 eixos totalmente estabilizada com uma câmara que integra um sensor CMOS de 1" (desenvolvida em conjunto pela DJI e pela Hasselblad) que capta vídeos a 4K e fotografias de 20 megapixels. As tecnologias com a assinatura DJI, como a detecção de obstáculos e os modos de voo inteligente, como o HyperLapse, ActiveTrack™ 2.0, QuickShot, Panorama, e os Sistemas avançados de assistência ao piloto, ajudam a captar imagens complexas de forma fácil. O Mavic 2 Pro conta com uma velocidade de voo máxima de 72 km/h (44,7 mi/h) e um tempo de voo máximo** de 31 minutos.

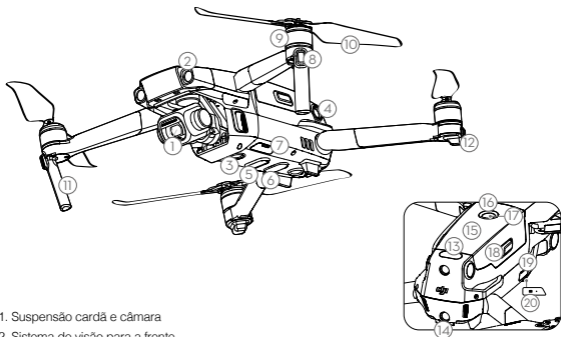

- | | | |
|---|---|---|
| 1. Suspensão cardã e câmara | 10. Hélices | 16. LED de nível da bateria |
| 2. Sistema de visão para a frente | 11. Antenas | 17. Botão de alimentação |
| 3. Sistema de visão para baixo | 12. Indicador de estado da aeronave | 18. Fivelas da bateria |
| 4. Sistema de visão lateral | 13. Sistema de detecção de infravermelhos para cima | 19. Porta USB-C |
| 5. Sistema de detecção de infravermelhos para baixo | 14. Sistema de visão para trás | 20. Botão de ligação/Indicador de estado da ligação |
| 6. Luz auxiliar inferior | 15. Bateria de voo inteligente | |
| 7. Ranhura para cartão microSD | | |
| 8. LED frontais | | |
| 9. Motores | | |

* Os Sistemas de visão e os Sistemas de detecção de infravermelhos são afetados pelas condições ambiente. Consulte a Declaração de exoneração de responsabilidade, as Diretrizes de segurança e o Manual do utilizador e assista aos vídeos tutoriais na aplicação DJI GO™ 4 ou no website oficial da DJI para saber mais.
<http://www.dji.com/mavic-2>

** O tempo máximo de voo foi testado num ambiente sem vento e a uma velocidade de voo constante de 25 km/h (15,5 mi/h). Este valor serve meramente como referência.

Telecomando

A tecnologia de transmissão de longo alcance OCUSYNC™ 2.0 da DJI está incorporada no telecomando, oferecendo um alcance máximo de transmissão de 8 km (5 mi) e enviando vídeo da aeronave para a aplicação DJI GO 4 no seu dispositivo móvel até 1080p. O ecrã LCD incorporado fornece informações em tempo real dos dados da aeronave e os manipululos de controlo amovíveis tomam o telecomando mais fácil de guardar.

Tempo máximo de funcionamento: 2 horas e 15 minutos*



Dobrado

1. Ecrã LCD
2. Botão de pausa do voo
3. Botão 5D
4. Manipulos de controlo amovíveis
5. Botão de alimentação
6. Antenas
7. Botão para voltar à posição inicial (RTH)
8. Ranhura para armazenamento dos manipululos de controlo
9. Porta de reserva para ligação de vídeo (USB)
10. Grampo para dispositivo móvel

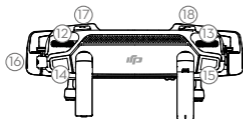
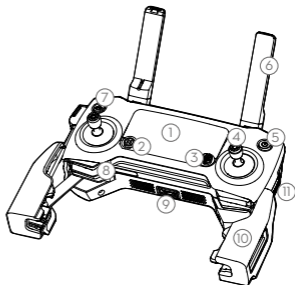

11. Interruptor de modo de voo
12. Botão da suspensão cardã
13. Seletor de ajuste de obturador/abertura
14. Botão de gravação
15. Botão de focagem/obturador
16. Porta de alimentação/ligação de vídeo (micro USB)
17. Botão C1 (personalizável)
18. Botão C2 (personalizável)

* O telecomando pode alcançar a sua distância máxima de transmissão (FCC) numa área ampla e aberta, sem interferência eletromagnética, a uma altitude de cerca de 120 m (400 pés). O tempo máximo de funcionamento é testado em ambiente de laboratório. Este valor serve meramente como referência.

1. Transferir a aplicação DJI GO 4 e ver os vídeos tutoriais

Pesquise "DJI GO 4" na App Store ou no Google Play, ou leia o código QR abaixo para transferir a aplicação para o seu dispositivo móvel.



DJI GO 4

Veja os vídeos tutoriais em www.dji.com/mavic-2 ou na aplicação DJI GO 4 tocando no ícone no canto superior direito do ecrã.



Vídeos tutoriais



A DJI GO 4 é compatível com iOS 9.0 (ou posterior) e Android 4.4 (ou posterior).

2. Preparar a aeronave

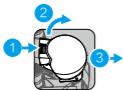

Retire a cobertura da suspensão cardá da câmara.



Desdobre os braços dianteiros.



Desdobre os braços traseiros.



Com marcas Sem marcas

Faça corresponder as hélices aos motores.



Pressione as hélices firmemente para baixo e rode na direção de bloqueio.



Desdobrados



Desdobre os braços dianteiros e as hélices antes dos traseiros. Todos os braços e hélices têm de ser desdobrados antes de descolar.

3. Carregamento das baterias

Utilize o carregador fornecido para carregar completamente a bateria de voo inteligente antes da primeira utilização.

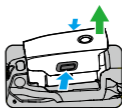

Remova a bateria de voo inteligente

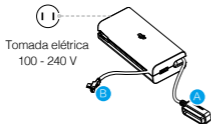

Tempo de carregamento:
~1 hora e 30 minutos

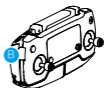

Tempo de carregamento:
~2 horas e 15 minutos

 Retire o cabo do telemando antes de carregar.

* Verificar os níveis da bateria e ligar/desligar

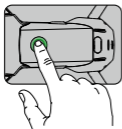

Prima uma vez para verificar o nível da bateria. Prima e, em seguida, prima e mantenha premido para ligar/desligar.

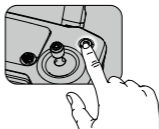

BAT 100 PCT

Prima uma vez para verificar o nível da bateria no ecrã LCD.

Prima uma vez e, em seguida, prima e mantenha premido para ligar/desligar o telemando.

4. Preparar o telecomando

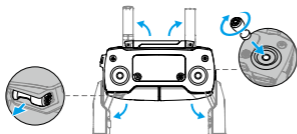

Desdobre as antenas e as braçadeiras para o dispositivo móvel e monte os manipuladores de controlo.



Insira uma ponta do cabo RC até ao final da ranhura.

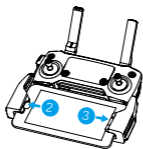

Fixe o seu dispositivo móvel entre as braçadeiras.



Forte



Fraco

Coloque as antenas paralelamente uma à outra

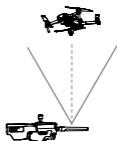
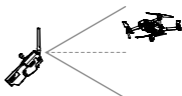

Alcance de transmissão ideal

- Certifique-se de que os manipuladores de controlo estão firmemente montados.
- O cabo do telecomando com o conector Lightning está montado por predefinição. Utilize o cabo adequado para ligar o seu dispositivo móvel ao telecomando. Quando utilizar um iPad ou um tablet, utilize a porta USB do telecomando.
- Não utilize portas micro USB e USB em simultâneo para a ligação de vídeo.

5. Preparar a descolagem



Ligue o telecomando



Ligue a aeronave



Inicie a DJI GO 4



Utilize a sua conta DJI para ativar a aeronave. A ativação requer uma ligação à Internet.

6. Voo

Antes de descolar, assegure-se de que a barra de estado da aeronave na aplicação DJI GO 4 indica "Ready to Go".

Ready to Go (GPS)

• Descolagem/Aterragem automática



Descolagem automática



Aterragem automática

• Descolagem/Aterragem manual

Comando de manipuladores combinados para ligar/desligar os motores



OU



Desloque lentamente o manipulador esquerdo para cima para descolar



Desloque lentamente o manipulador esquerdo para baixo até que a aeronave toque no solo. Mantenha premido durante alguns segundos para parar os motores



Os motores só podem ser parados em pleno voo quando o controlador deteta um erro crítico.

* Operação do telecomando

O controlo de voo predefinido é conhecido como Modo 2. O manípulo esquerdo controla a altitude e o rumo da aeronave e o manípulo direito controla os movimentos para a frente, para trás, para a esquerda e para a direita. O botão da suspensão cardã controla a inclinação da câmara.

Manípulo esquerdo



Para cima



Para baixo



Virar à esquerda

Virar à direita

Manípulo direito

Para a frente



Para trás



Esquerda

Direita



Prima o botão de pausa do voo para travagens de emergência durante o voo.

* Na aplicação DJI GO 4



Normal



HyperLapse



QuickShot



ActiveTrack



Point of Interest



Waypoints



TapFly



Modo de cinema



- Assista aos tutoriais na aplicação DJI GO 4 ou no website oficial da DJI para obter mais informações.
- Defina sempre uma altitude RTH adequada antes da descolagem. Quando a aeronave está a voltar ao ponto inicial, deverá dirigi-la com os manípulos de controlo.

7. Voar com segurança



Voar em áreas abertas

+



Sinal de GPS forte

+



Manter a linha de visão

+



Voar abaixo dos 120 m (400 pés)



Evite voar por cima ou perto de obstáculos, multidões, linhas elétricas de alta tensão, árvores e massas de água.

NÃO voe próximo de fontes eletromagnéticas fortes, tais como linhas de alta tensão e estações de rede móvel, pois estas podem afetar a bússola integrada.



NÃO utilize a aeronave em condições atmosféricas adversas, tais como chuva, neve, nevoeiro e ventos com velocidades superiores a 10 m/s ou 35,4 km/h.



Mantenha-se afastado das hélices e dos motores em rotação.



Zona de exclusão aérea

Saiba mais em:
<http://fllysafe.dji.com/no-fly>



É importante compreender as diretrizes básicas de voo para a segurança do utilizador e dos que o rodeiam. Não se esqueça de ler a **Declaração de exoneração de responsabilidade e as diretrizes de segurança**.

Características técnicas

• Aeronave

Peso	907 g
Velocidade máxima	72 km/h (44,7 mi/h) no modo desportivo sem vento
Limite de funcionamento máximo acima do nível do mar	6000 m (19 685 pés)
Temperatura de funcionamento	14 °F a 104 °F (-10 °C a 40 °C)
GNSS	GPS + GLONASS
Frequência de funcionamento	2,4 - 2,4835 GHz; 5,725 - 5,850 GHz
Potência do transmissor (EIRP)	2,4 GHz FCC: ≤26 dBm; CE/MIC: ≤20 dBm; SRRC: ≤20 dBm 5,8 GHz FCC: ≤26 dBm; CE: ≤14 dBm; SRRC: ≤26 dBm

• Suspensão cardíaca

Amplitude controlável	Inclinação: -90° a +30°
-----------------------	-------------------------

• Câmera

Sensor	CMOS de 1"; pixels reais: 20M
Lente	FOV: approx. 77° Equivalente ao formato de 35 mm: 28 mm Abertura: f/2.8-f/11 Focagem: 1 m a ∞
Gama ISO	Vídeo: 100-6400 Fotografia: 100-3200 (auto); 100-12 800 (manual)
Velocidade do obturador eletrônico	8-1/8000 s
Tamanho máximo da imagem	5472 x 3648
Modos de fotografia	Disparo único Disparos contínuos: 3/5 fotografias Variação da exposição automática (AEB): 3/5 fotografias com variação a 0,7 EV Intervalo
Modos de gravação de vídeo	4K Ultra HD: 3840 × 2160, 24/25/30p 2,7K: 2688 × 1512, 24/25/30/48/50/60p FHD: 1920×1080 24/25/30/48/50/60/120p
Taxa de bits de armazenamento de vídeo	100 Mbps
Fotografia	JPEG, DNG (RAW)
Vídeo	MP4, MOV (MPEG-4 AVC/H.264, HEVC)
Cartões SD compatíveis	microSD Capacidade máxima: 128 GB (classificação necessária: UHS-I Speed Grade 3)

• Telecomando

Frequência de funcionamento	2,4 - 2,4835 GHz; 5,725 - 5,850 GHz
Distância máxima de transmissão (desobstruído e sem interferências)	FCC: 8 km (5 mi), CE/MIC: 5 km (3,1 mi); SRRC: 5 km (3,1 mi)
Temperatura de funcionamento	0 °C a 40 °C (32 °F a 104 °F)

Bateria	3950 mAh a 3,83 V
Potência do transmissor (EIRP)	2,4 GHz FCC: ≤26 dBm; CE/MIC: ≤20 dBm; SRRC: ≤20 dBm 5,8 GHz FCC: ≤26 dBm; CE: ≤14 dBm; SRRC: ≤26 dBm
Tensão de funcionamento	1800 mA a 3,83 V (ao carregar o dispositivo móvel)
Dimensões dos dispositivos móveis suportados	Espessura suportada: 6,5 - 8,5 mm, Comprimento máximo: 160 mm Tipos de portas USB suportados: Lightning, Micro USB (Type-B) USB-C
• Carregador	
Tensão	17,6 ± 0,1 V
Potência nominal	60 W
• Bateria de voo inteligente	
Capacidade	3850 mAh
Tensão	17,6 V (máx.) 15,4 V (típico)
Tipo de bateria	LiPo 4S
Energia	59,29 Wh
Peso líquido	Aprox. 297 g
Intervalo de temperatura de carregamento	5 °C a 40 °C (41 °F a 104 °F)
Potência máx. de carregamento	80 W

Para mais informações, consulte o manual do utilizador:
<http://www.dji.com/mavic-2>

※ Este conteúdo está sujeito a alterações sem aviso prévio.

MAVIC é uma marca comercial da DJI.
 Copyright © 2018 DJI Todos os direitos reservados.

Criado pela DJI. Impresso na China.

Дрон

DJI™ MAVIC™ 2 Pro оснащен системами обзора во всех направлениях и системами инфракрасных датчиков* и камерой на 3-осевом стабилизаторе с матрицей CMOS 1" (совместная разработка DJI и Hasselblad), позволяющей снимать видео в формате 4K и фото с разрешением 20 Мп. Такие фирменные технологии DJI, как система обнаружения препятствий, и интеллектуальные режимы полета — гиперлапс (Hyperlapse), ActiveTrack™ 2.0, быстрая съемка (QuickShot), панорама — а также расширенный автопилот (APAS) позволяют без проблем выполнять сложную съемку. Максимальная скорость полета Mavic 2 Pro составляет 72 км/ч (44,7 мили/ч), а максимальное время полета** — 31 минута.

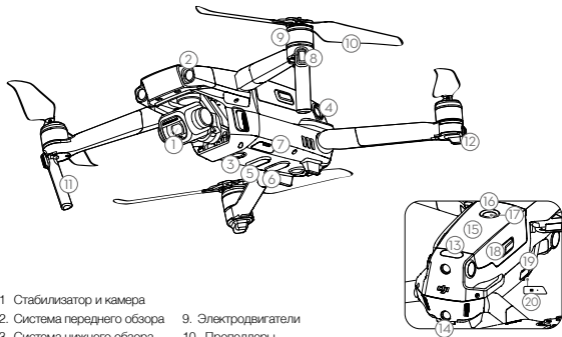

- | | | |
|---|--|--|
| 1. Стабилизатор и камера | 9. Электродвигатели | 17. Кнопка питания |
| 2. Система переднего обзора | 10. Пропеллеры | 18. Зажимы крепления аккумулятора |
| 3. Система нижнего обзора | 11. Антенны | 19. Порт USB-C |
| 4. Система бокового обзора | 12. Индикатор состояния дрона | 20. Кнопка подключения/индикатор состояния подключения |
| 5. Система нижних инфракрасных датчиков | 13. Система верхних инфракрасных датчиков | |
| 6. Вспомогательный нижний фонарь | 14. Система заднего обзора | |
| 7. Слот для карты памяти microSD | 15. Аккумулятор Intelligent Flight Battery | |
| 8. Передние огни | 16. Светодиодные индикаторы уровня заряда аккумулятора | |

* Работа систем обзора и систем инфракрасных датчиков зависит от условий окружающей среды. Для получения дополнительной информации ознакомьтесь с отказом от ответственности и руководством по технике безопасности, руководством пользователя и посмотрите видеоролики в приложении DJI GO™ 4 или на официальном веб-сайте DJI. <http://www.dji.com/mavic-2>

** Результат, полученный во время испытаний при полете в безветренных условиях с постоянной скоростью 25 км/ч (15,5 мили/ч). Данное значение приведено исключительно в справочных целях.

Пульт дистанционного управления

В пульт дистанционного управления встроена технология DJI OCUSSYNC™ 2.0 для передачи данных на большие расстояния, обеспечивающая максимальное расстояние передачи сигнала 8 км (5 миль), а также передачу видео с дрона в приложение DJI GO 4 на мобильном устройстве с разрешением до 1080p. Встроенный ЖК-экран передает данные дрона в режиме реального времени, а съемные джойстики упрощают хранение пульта дистанционного управления. Максимальное время работы: 2 часа и 15 минут*



В сложенном состоянии

1. ЖК-экран
2. Кнопка остановки режима полета
3. Кнопка 5D
4. Съемные джойстики
5. Кнопка питания
6. Антенны
7. Кнопка «возврата домой»
8. Слот для хранения джойстиков
9. Резервный порт для передачи видеоданных (USB)
10. Зажим мобильного устройства
11. Переключатель режимов полета

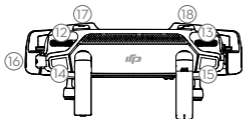
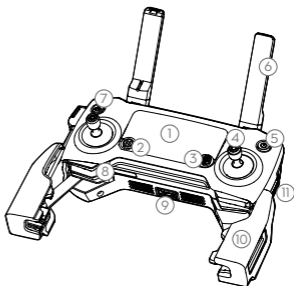

12. Колесико наклона камеры
13. Колесико настройки диафрагмы/ скорости затвора
14. Кнопка записи
15. Кнопка экспозамера/спуска затвора
16. Порт передачи видеоданных/разъем питания (micro USB)
17. Кнопка C1 (настраиваемая)
18. Кнопка C2 (настраиваемая)

* Пульт дистанционного управления может работать на максимальном расстоянии передачи сигнала (FCC) на открытом пространстве без электромагнитных помех при высоте полета около 120 м (400 футов). Максимальное время работы измерено в лабораторных условиях. Данное значение приведено исключительно в справочных целях.

1. Загрузите приложение DJI GO 4 и посмотрите обучающие видеоролики

Найдите приложение «DJI GO 4» в App Store или Google Play либо отсканируйте QR-код, расположенный ниже, чтобы загрузить приложение на свое мобильное устройство.



DJI GO 4

Посмотрите обучающие видеоролики на странице www.dji.com/mavic-2 или в приложении DJI GO 4, нажав на значок в правом верхнем углу экрана.



Обучающие видеоролики



DJI GO 4 поддерживает iOS 9.0 (или более позднюю версию) и Android 4.4 (или более позднюю версию).

2. Подготовка дрона

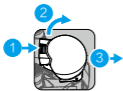

Снимите чехол стабилизатора с камеры.



Разложите передние лучи.



Разложите задние лучи.



С маркировкой Без маркировки

Соблюдайте цветовую кодировку пропеллеров и электродвигателей.



Надавите на пропеллер и поворачивайте в направлении блокировки.



Разложенное состояние



Всегда раскладываете сначала передние лучи, затем — задние. Все лучи и пропеллеры должны находиться в разложенном состоянии перед взлетом.

3. Зарядка аккумуляторов

Используйте предоставленное в комплекте зарядное устройство, чтобы полностью зарядить аккумулятор Intelligent Flight Battery перед первым использованием.

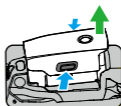

Снимите аккумулятор Intelligent Flight Battery



Время зарядки:
~1 час 30 минут

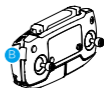

Время зарядки:
~2 часа 15 минут



Снимите кабель пульта дистанционного управления перед зарядкой.

* Проверьте уровень заряда аккумуляторов и включите/выключите питание

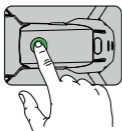

Нажмите один раз для проверки уровня заряда аккумулятора.
Нажмите один раз, затем нажмите и удерживайте для включения/выключения.

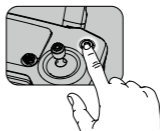

BAT 100 PCT

Нажмите один раз для проверки уровня заряда аккумулятора на ЖК-экране.
Нажмите один раз, затем нажмите и удерживайте для включения/выключения пульта дистанционного управления.

4. Подготовка пульта дистанционного управления к работе

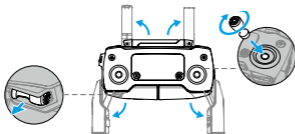

Разверните антенны, зажмите мобильного устройства и установите джойстики.



Сильный сигнал



Слабый сигнал

Установите антенны параллельно друг другу



Подсоедините один конец кабеля пульта дистанционного управления к разъему.

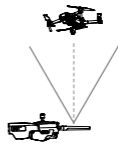
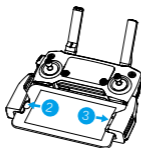
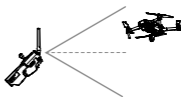

Оптимальный диапазон передачи сигнала

Закрепите ваше мобильное устройство с помощью зажимов.



- Убедитесь, что джойстики надежно закреплены.
- Кабель пульта дистанционного управления с разъемом Lightning установлен по умолчанию. Используйте подходящий для вашего мобильного устройства кабель для подключения к пульта дистанционного управления. При работе с iPad или планшетом используйте порт USB на пульте дистанционного управления.
- Не используйте порты Micro USB и USB одновременно для подключения видео.

5. Подготовка к взлету



Включите пульт дистанционного управления



Включите дрон



Запустите DJI GO 4



Интернет

Для активации дрона используйте вашу учетную запись DJI. Для этого потребуется соединение с интернетом.

RU

6. Полет

Перед взлетом убедитесь, что в строке состояния дрона в приложении DJI GO 4 показано Ready to Go (Полет разрешен).

Ready to Go (GPS)

• Автоматический взлет / посадка



Автоматический взлет



Автоматическая посадка

• Ручной взлет / посадка

Положение джойстиков для включения/выключения электродвигателей



ИЛИ



Плавное сдвиньте левый джойстик вверх для взлета



Смещайте левый джойстик вниз (плавно), пока дрон не коснется поверхности. Для выключения двигателей удерживайте джойстик в нижнем положении в течение нескольких секунд.



Двигатели можно останавливать во время полета, только если полетный контроллер обнаруживает критическую ошибку.

* Эксплуатация пульта дистанционного управления

Режим 2 является режимом управления по умолчанию. Левый джойстик используется для управления высотой и поворотом дрона, правый — для управления движением вперед, назад, влево и вправо. Колесико стабилизатора управляет наклоном камеры.

Левый джойстик



Вверх



Вниз



Поворот
налево

Поворот
направо

Правый джойстик



Вперед



Назад



Влево

Вправо



Нажмите на кнопку остановки режима полета для аварийного торможения во время полета.

* В DJI GO 4



Нормальное
состояние



HyperLapse



QuickShot



ActiveTrack



«Точка интереса»
(Point of Interest)



«Полет по точкам»
(Waypoints)



TapFly



«Кинематографический режим»
(Cinematic mode)



- Для получения дополнительной информации посмотрите обучающие видеоролики в приложении DJI GO 4 или на официальном веб-сайте DJI.
- Перед взлетом всегда устанавливайте подходящую высоту для возврата домой. При возврате в исходную точку дрон необходимо направлять с помощью джойстиков.

7. Соблюдайте правила безопасности полетов



Выполняйте полеты на открытых участках



При сильном сигнале спутников



Выполняйте полет только в пределах прямой видимости



Выполняйте полет на высоте ниже 120 м (400 футов)



Следует избегать полетов над или в непосредственной близости от препятствий, скопления людей, высоковольтных линий электропередачи, деревьев и водоемов. ЗАПРЕЩАЕТСЯ выполнять полеты близко от таких источников сильного электромагнитного поля, как линии электропередачи и базовые станции, т. к. они могут влиять на работу встроенного компаса.



ЗАПРЕЩАЕТСЯ использовать дрон в неблагоприятных погодных условиях, таких как дождь, снег, туман и при скорости ветра более 10 м/с или 22 миль/ч.



Не приближайтесь к вращающимся пропеллерам и электродвигателям.



Зоны, запрещенные для полетов

Более подробная информация приведена на веб-сайте: <http://flysafe.dji.com/no-fly>



Для обеспечения своей безопасности и безопасности окружающих важно понимать основные принципы полета. Для получения дополнительной информации обратитесь к отказу от ответственности и руководству по технике безопасности.

Технические характеристики

• Дрон

Масса	907 г
Максимальная скорость	72 км/ч (44,7 мили/ч) в спортивном режиме в безветренную погоду
Максимальная высота полета над уровнем моря	6000 м (19 685 футов)
Диапазон рабочих температур	от -10 до 40 °C (от 14 до 104 °F)
GNSS	GPS + ГЛОНАСС
Рабочая частота	2,4-2,4835 ГГц
Мощность передатчика (ЭИИМ)	2,4 ГГц FCC: ≤26 дБм; CE/MIC: ≤20 дБм; SRRC: ≤20 дБм

• Стабилизатор

Рабочий диапазон углов вращения	Наклон: от -90° до +30°
---------------------------------	-------------------------

• Камера

Матрица	CMOS размером 1 дюйм; количество эффективных пикселей: 20 Мп
Объектив	Угол обзора: приблиз. 77° эквивалент формата 35 мм: 28 мм Диафрагма: f/2,8-f/11 Фокус: от 1 м до ∞
Диапазон ISO	Видео: 100-6400 Фото: 100-3200 (режим авто); 100-12 800 (ручной режим)
Диапазон выдержки	8-1/8000 с
Максимальный размер изображения	5472×3648
Режимы фотосъемки	Единый снимок Серийная съемка: 3/5 кадров Автоматический брекетинг экспозиции (АЕВ): брекетинг кадра 3/5 с шагом 0,7 EV Автоспуск
Разрешение видео	4K Ultra HD: 3840×2160, 24/25/30 кадров/с 2.7K: 2688×1512, 24/25/30/48/50/60 кадров/с FHD: 1920×1080 24/25/30/48/50/60/120 кадров/с
Битрейт видео	100 Мбит/с
Фото	JPEG, DNG (RAW)
Видео	MP4, MOV (MPEG-4 AVC/H.264, HEVC)
Совместимые карты памяти	microSD Максимальный объем: 128 Гбайт (требуется UHS-1, класс скорости 3)

• Пульт дистанционного управления

Рабочая частота	2,4-2,4835 ГГц
Макс. расстояние передачи сигнала (При отсутствии препятствий и помех)	FCC: 8 км (5 мили); CE/MIC: 5 км (3,1 мили); SRCC: 5 км (3,1 мили)
Диапазон рабочих температур	от 0 до 40 °C (от 32 до 104 °F)
Аккумулятор	3950 мАч при 3,83 В

Мощность передатчика (ЭИИИМ)	2,4 ГГц FCC: ≤26 дБм; CE/MIC: ≤20 дБм; SRRC: ≤20 дБм
Рабочее напряжение	1800 мА при 3,83 В (при зарядке мобильного устройства)
Размер совместимого мобильного устройства	Толщина: 6,5–8,5 мм, макс. длина: 160 мм Поддерживаемые типы портов USB Lightning, Micro USB (Type-B) USB-C

• **Зарядное устройство**

Напряжение	17,6±0,1 В
Номинальная мощность	60 Вт

• **Аккумулятор Intelligent Flight Battery**

Емкость	3850 мАч
Напряжение	17,6 В (макс.) 15,4 В (стандартн.)
Тип аккумулятора	Литий-полимерный 4S
Емкость	59,29 Вт·ч
Масса	Около 297 г
Диапазон температуры зарядки	от +5 до +40 °C (от 41 до 104 °F)
Максимальная мощность зарядки	80 Вт

Дополнительную информацию можно найти в руководстве пользователя:
<http://www.dji.com/mavic-2>

※ Эта отметка означает, что содержание может быть изменено без предварительного уведомления.

MAVIC является товарным знаком компании DJI.
© 2018 DJI Все права защищены.

Разработано DJI. Напечатано в Китае.

MAVIC 2 PRO



For online support, please scan this code
with Facebook Messenger



0M6DPARM01EU