

MAVIC 2 PRO/ZOOM

User Manual v1.0

2018.08

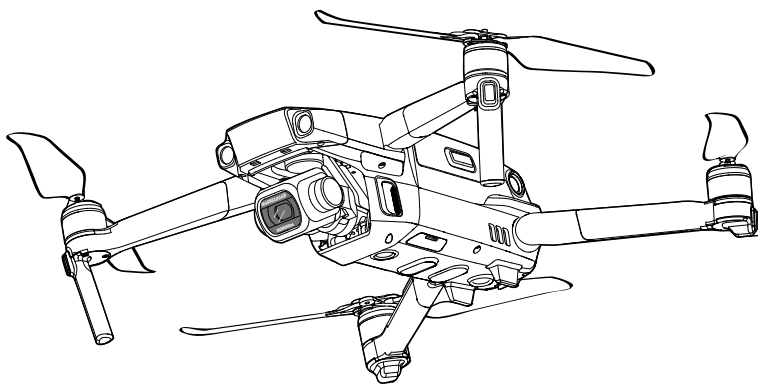

Searching for Keywords

Search for keywords such as “battery” and “install” to find a topic. If you are using Adobe Acrobat Reader to read this document, press Ctrl+F on Windows or Command+F on Mac to begin a search.

Navigating to a Topic

View a complete list of topics in the table of contents. Click on a topic to navigate to that section.

Printing this Document

This document supports high resolution printing.

Using This Manual

Legend

 Warning

 Important

 Hints and Tips

 Reference

Read Before the First Flight

Read the following documents before using the MAVIC™ 2 Pro/Zoom:

1. *Mavic 2 Pro/Zoom In the Box*
2. *Mavic 2 Pro/Zoom User Manual*
3. *Mavic 2 Pro/Zoom Quick Start Guide*
4. *Mavic 2 Pro/Zoom Disclaimer and Safety Guidelines*
5. *Mavic 2 Pro/Zoom Intelligent Flight Battery Safety Guidelines*

It is recommend to watch all tutorial videos on the official DJI™ website and read the *Mavic 2 Pro/Zoom Disclaimer and Safety Guidelines* before first time use. Prepare for your first flight by reviewing the *Mavic 2 Pro/Zoom Quick Start Guide* and refer to this *Mavic 2 Pro/Zoom User Manual* for more details.

Video Tutorials

Go to the address below or scan the QR code on the right to watch the Mavic 2 Pro/Zoom tutorial videos, which demonstrate how to use the Mavic 2 Pro/Zoom safely:

<http://www.dji.com/mavic-2/info#video>



Download the DJI GO 4 App

Be sure to use the DJI GO™ 4 app during flight. * Scan the QR code on the right to download the latest version. The Android version of DJI GO 4 is compatible with Android v4.4 and later. The iOS version of DJI GO 4 is compatible with iOS v9.0 and later.



* For increased safety, flight is restricted to a height of 98.4 ft (30 m) and range of 164 ft (50 m) when not connected or logged into the app during flight. This applies to DJI GO 4 and all apps compatible with DJI aircraft.

Download DJI Assistant 2

Download DJI Assistant 2 at <http://www.dji.com/mavic-2/info#downloads>.

Contents

Using This Manual	2
Legend	2
Read Before the First Flight	2
Video Tutorials	2
Download the DJI GO 4 App	2
Download DJI Assistant 2	2
Product Profile	6
Introduction	6
Preparing the Mavic 2 Pro/Zoom	6
Preparing the Remote Controller	8
Aircraft Diagram	9
Activation	11
Aircraft	13
Flight Modes	13
Aircraft LEDs and Status Indicator	14
Return to Home	15
Vision Systems and Infrared Sensing Systems	20
Intelligent Flight Modes	23
Advanced Pilot Assistance Systems	32
Flight Recorder	32
Attaching and Detaching the Propellers	33
Intelligent Flight Battery	34
Gimbal and Camera	37
Remote Controller	40
Using the Remote Controller	40
Dual Remote Controller Mode (Coming soon)	46
Linking the Remote Controller	47
DJI GO 4 App	49
Equipment	49
Editor	52
SkyPixel	52
Me	52

Flight	55
Flight Environment Requirements	55
Flight Limits and GEO Zones	55
Pre-Flight Checklist	57
Auto Takeoff/Landing	57
Starting/Stopping the Motors	58
Test Flight	58
Appendix	61
Specifications	61
Calibrating the Compass	64
Firmware Updates	65
Remote Controller LCD Screen Menu Information	66
After-Sales Information	68

Product Profile

This section introduces Mavic 2 Pro/Zoom and lists the components of the aircraft and remote controller.

Product Profile

Introduction

The DJI Mavic 2 Pro/Zoom features omnidirectional Vision Systems and Infrared Sensing Systems. Effortlessly capture complex shots using signature DJI technologies such as Obstacle Sensing and Intelligent Flight Modes like Hyperlapse, Point of Interest, ActiveTrack™ 2.0, TapFly, QuickShots, and Advanced Pilot Assistance Systems (APAS).

The Mavic 2 Pro features a fully stabilized 3-axis gimbal with a 1" CMOS sensor camera (jointly developed by DJI and Hasselblad) that shoots 4K video, 20-megapixel photos, and supports filters. The Mavic 2 Zoom features a fully stabilized 3-axis gimbal camera that shoots 4K video, 12-megapixel photos, supports 2x optical zoom, and 24-48 mm lens, and supports filters.

The Mavic 2 Pro/Zoom uses the latest technology to increase stability and footage quality, reducing the Mavic 2 Zoom angle vibration range to within $\pm 0.005^\circ$ and Mavic 2 Pro angle vibration range to within $\pm 0.01^\circ$.

Built into the remote controller is the DJI's long-range transmission technology Ocusync™ 2.0, offering a maximum transmission range of 5 mi (8 km) and displaying video from the aircraft on to DJI GO 4 on your mobile device at up to 1080p. The remote controller works at both 2.4 GHz and 5.8 GHz, and it can select the best transmission channel automatically without any latency. The aircraft and camera can easily be controlled using the onboard buttons. An onboard LCD screen gives real-time aircraft data information, and the detachable control sticks make the remote controller easier to store. The maximum run time is 2 hours and 15 minutes. The Mavic 2 Pro/Zoom boasts a maximum flight speed of 44.7 mph (72 kph) and a maximum flight time of 31 minutes.



- The major difference between the Mavic 2 Pro and Mavic 2 Zoom is the camera. The general descriptions in this manual apply to both Mavic 2 Pro/Zoom.



- Maximum flight time was tested in an environment with no wind while flying at a consistent 15.5 mph (25 kph) and the maximum flight speed was tested at sea level altitude with no wind. These values are for reference only.
- The remote controller reaches its maximum transmission distance (FCC) in a wide-open area with no electromagnetic interference at an altitude of about 400 ft (120 m). The maximum runtime was tested in a laboratory environment. This value is for reference only.
- 5.8 GHz is not supported in some regions. Please observe the local laws and regulations.

Preparing the Mavic 2 Pro/Zoom

Preparing the Aircraft

All aircraft arms are folded before the aircraft is packaged at the factory. Follow the steps below to unfold the aircraft.

1. Remove the gimbal cover from the camera.
2. Unfold the front arms, and then unfold the rear arms.

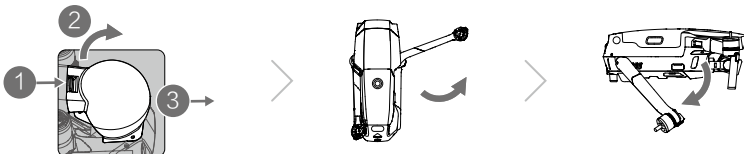

*Attach the gimbal cover when not in use.

- 1) Hold the gimbal in place and insert gimbal clamp between the aircraft and the gimbal.
- 2) Make sure the hooks on the Gimbal Protector are locked in the grooves of the aircraft, then lower the Gimbal Protector over the gimbal and secure with the buckle. The buckle will click when it is securely attached.

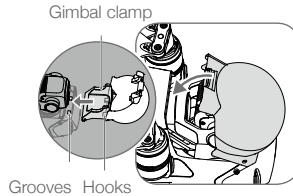

3. Attaching the propellers.

Attach the propellers marked white to the motors with white marks. Press the propeller down onto the motors and turn until it is secure. Attach the other propellers to the unmarked motors. Unfold the propeller blades.



4. All Intelligent Flight Batteries are in Hibernation mode before shipment to ensure safety. Use the provided AC power adapter to charge and activate Intelligent Flight Batteries for the first time. To charge an Intelligent Flight Battery after flight, remove it from the aircraft and attach it to the AC power adapter.

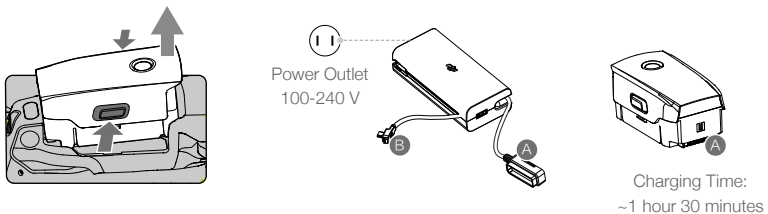

- Unfold the front arms and propellers before unfolding the rear arms.
- Be sure the gimbal cover is removed and all arms and propellers are unfolded before powering on the aircraft. Otherwise, it may affect the aircraft self-diagnostics.

Preparing the Remote Controller

1. Unfold the mobile device clamps and the antennas.
2. Remove the control sticks from their storage slots on the remote controller and screw them into place.

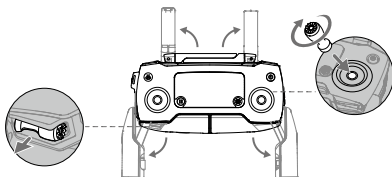

3. Choose an appropriate RC cable based on the type of mobile device. A cable with a Lightning connector is connected by default to the cable slider. Micro USB and USB-C cables are also included in the packaging. Connect the end of the RC cable to your mobile device. Secure your mobile device by pushing both clamps inward.

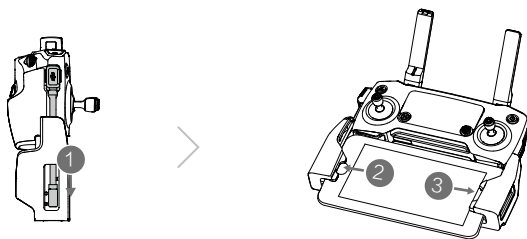

Refer to the figure below for how to replace the RC cable. The RC cable slider must be replaced if using a USB -C RC cable.



- You can also connect your mobile device to the remote controller using a USB cable if the mobile device is too big to place into the clamps. Plug one end of the cable into your mobile device and the other end into the USB port on the bottom of the remote controller.
- Do not use the Micro USB and USB ports simultaneously for video linking. Remove the cable from one port before connecting a device to the other port for video linking.

Aircraft Diagram

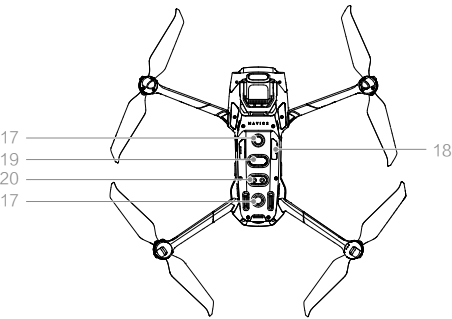
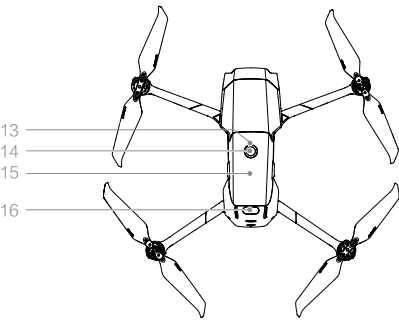
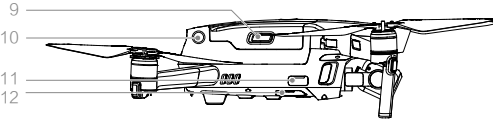
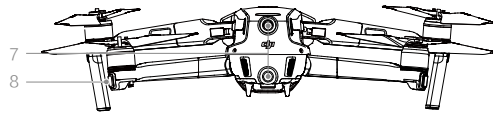
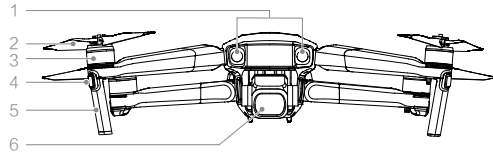

1. Forward Vision System
2. Propellers
3. Motors
4. Front LEDs
5. Antennas
6. Gimbal and Camera
7. Backward Vision System
8. Aircraft Status Indicator
9. Battery Buckles
10. Lateral Vision System
11. USB-C Port
12. Link Button/Linking Status Indicator
13. Battery Level LEDs
14. Power Button
15. Intelligent Flight Battery
16. Upward Infrared Sensing System
17. Downward Vision System
18. microSD Card Slot
19. Downward Infrared Sensing System
20. Auxiliary Bottom Light

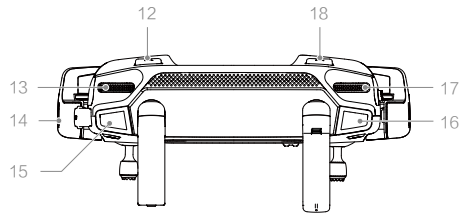
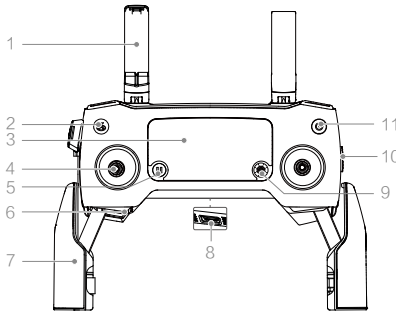

1. Antennas

Relay aircraft control and video wireless signals.

2. Return to Home (RTH) Button

Press and hold the button to initiate RTH. The aircraft returns to the last recorded home point. Press again to cancel RTH.

3. LCD Screen

Displays the aircraft and Remote Controller system status.

4. Removable Control Sticks

The removable control sticks are easy to store. The default flight control is set to Mode 2. Set the flight control mode in DJI GO 4.

5. Flight Pause Button

Press to make the aircraft brake and hover in place (only when GPS or Vision System are available). Please note that the flight pause button has different functions in different Intelligent Flight Modes. For details, refer to the Intelligent Flight Mode section.

6. Control Sticks Storage Slot

For storing the control sticks.

7. Mobile Device Clamps

Securely mount your mobile device onto the remote controller.

8. Reserve Video-Downlink Port (USB)

Connect to a mobile device for video

downlink via a standard USB cable.

9. 5D Button

The default configuration is listed below. The configuration can be adjusted based on your preferences in DJI GO 4.

Left: Decrease EV value.

Right: Increase EV value.

Up: Recenter gimbal/gimbal downward.

Down: Recenter gimbal/gimbal downward.

Press down: Bring up DJI GO 4 Intelligent Flight menu.

10. Flight Mode Switch

Switch between S-mode, P-mode, and T-mode.

11. Power Button

Press once to check the current battery level. Press once, then again, and hold to turn on/off the remote controller.

12. C1 Button (Customizable)

The default configuration is center focus. Adjust the configuration in DJI GO 4 based on your preferences.

13. Gimbal Dial

Controls the camera's tilt.

14. Video-Downlink/Power Port (micro USB)

Connect to a mobile device for video linking via the RC cable. Connect to the

AC Power Adapter to charge the remote controller battery.

15. **Record Button**

Press to start recording video. Press again to stop recording.

16. **Focus/Shutter Button**

Press halfway to autofocus. Press once to take photos according to the mode selected in the DJI GO 4.

17. **Aperture/Shutter Adjustment Dial (Mavic 2 Pro)**

Turn the dial to adjust the exposure compensation (when in P-mode), aperture (when in Aperture Priority and Manual mode), or shutter (when in S-mode).

Zoom Adjustment Dial (Mavic 2 Zoom)

Turn to adjust the zoom of the Mavic 2 Zoom camera.

18. **C2 Button (Customizable)**

The default configuration is playback. Adjust the configuration in DJI GO 4 based on your preferences.

Activation

The Mavic 2 Pro/Zoom requires activation before first time use. Follow the onscreen guide to activate the Mavic 2 Pro/Zoom using DJI GO 4.

Aircraft

This section introduces the flight controller, Forward, Backward and Downward Vision Systems, and the Intelligent Flight Battery.

Aircraft

The Mavic 2 Pro/Zoom contains a flight controller, vision systems, video downlink system, propulsion system, and an Intelligent Flight Battery. Refer to the aircraft diagram in the Product Profile section.

Flight Modes

The Mavic 2 Pro/Zoom has three flight modes, plus a fourth flight mode that the aircraft switches to in certain circumstances:

P-mode (Positioning): P-mode works best when the GPS signal is strong. The aircraft utilizes GPS and the Vision Systems to locate itself, stabilize, and navigate between obstacles. Intelligent Flight Modes are enabled in this mode.

When the Forward and Backward Vision Systems are enabled and lighting conditions are sufficient, the maximum flight altitude angle is 25°, the maximum forward flight speed is 31 mph (50 kph), and the maximum backward flight speed is 27 mph (43 kph).

Note: P-mode requires larger stick movements to achieve high speeds.

The aircraft automatically changes to Attitude (ATTI) mode when the Vision Systems are unavailable or disabled and when the GPS signal is weak or the compass experiences interference. When the Vision Systems are unavailable, the aircraft cannot position itself or brake automatically, which increases the risk of potential flight hazards. In ATTI mode, the aircraft may be more easily affected by its surroundings. Environmental factors such as wind can result in horizontal shifting, which may present hazards, especially when flying in confined spaces.

S-mode (Sport): In S-mode, the Vision Systems are disabled and the aircraft only uses GPS for positioning. The maximum flight speed is 44.7 mph (72kph). Intelligent Flight Modes are not available and the aircraft cannot sense or avoid obstacles.

Note: In S-mode, aircraft responses are optimized for agility and speed making it more responsive to stick movements.

T-mode (Tripod): T-mode is based on P-mode and the flight speed is limited, which makes the aircraft more stable during shooting. The maximum flight speed, maximum ascend speed and maximum descend speed are 1 m/s. Intelligent Flight Modes are not available in T-mode.



- The Forward, Backward, Lateral Vision Systems and the Upward Infrared Sensing System are disabled in S-mode, which means the aircraft cannot sense obstacles on its route automatically.
 - The aircraft's maximum speed and braking distance significantly increase in S-mode. A minimum braking distance of 98.4 ft (30 m) is required in windless conditions.
 - Descent speed significantly increases in S-mode.
 - The aircraft's responsiveness significantly increases in S-mode, which means a small stick movement on the remote controller translates into the aircraft moving a large distance. Be vigilant and maintain adequate maneuvering space during flight.
 - Use the Flight Mode switch on the remote controller to switch between Flight Modes. Enable Multiple Flight Modes in DJI GO 4 to switch between Flight Modes.
-

Aircraft LEDs and Status Indicator

The Mavic 2 Pro/Zoom has Front LEDs and Aircraft Status Indicators as shown in the figure below.

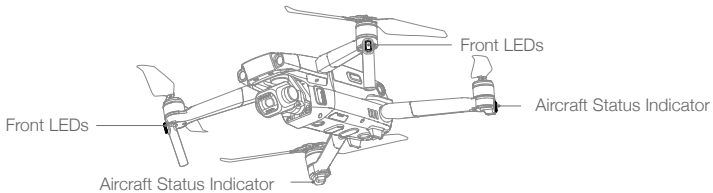

The Front LEDs show the orientation of the aircraft and glow solid red when the aircraft is turned on to indicate the front of the aircraft (they can be turned off in the DJI GO 4 app).



The Aircraft Status Indicators communicate the statuses of the aircraft's flight control system. Refer to the table below for more information about the aircraft states indicated by the Aircraft Status Indicators. The Aircraft Status Indicators also flash when the Home Point is being recorded, as described in the Return to Home section.

Aircraft Status Indicator States

	Color	Blinking/Solid	Description of Aircraft State
Normal States			
	Alternating red, green, and yellow	Blinking	Turning on and performing self-diagnostic tests
	Yellow	Blinks four times	Warming up
	Green	Blinking slowly	P-mode with GPS
	Green	Periodically blinks twice	P-mode with Forward and Downward Vision Systems
	Yellow	Blinking slowly	No GPS, Forward Vision System or Downward Vision System
	Green	Blinking quickly	Braking
Warning States			
	Yellow	Blinking quickly	Remote controller signal lost
	Red	Blinking slowly	Low battery
	Red	Blinking quickly	Critically low battery
	Red	Blinking	IMU error
	Red	Solid	Critical error
	Alternating red and yellow	Blinking quickly	Compass calibration required

Return to Home

The Return to Home (RTH) function brings the aircraft back to the last recorded Home Point. There are three types of RTH: Smart RTH, Low Battery RTH, and Failsafe RTH. This section describes these three scenarios in detail.

☰	GPS	Description
Home Point		If a strong GPS signal was acquired before takeoff, the Home Point is the location from which the aircraft launched. The GPS signal strength is indicated by the GPS icon (). The Aircraft Status Indicator will blink green quickly when the Home Point is recorded.

Smart RTH

If the GPS signal is sufficiently strong, Smart RTH can be used to bring the aircraft back to the Home Point. Smart RTH is initiated either by tapping  in the DJI GO 4 app (and following the on-screen instructions) or by pressing and holding the RTH button on the remote controller.

Exit Smart RTH by tapping  in the DJI GO 4 app or by pressing the RTH button on the remote controller.

Low Battery RTH

Low Battery RTH is triggered when the Intelligent Flight Battery is depleted to the point that the safe return of the aircraft may be affected. Return home or land the aircraft immediately when prompted. DJI GO 4 will display a warning when a low battery level warning is triggered. The aircraft will automatically return to the Home Point if no action is taken after a ten-second countdown. The user can cancel the RTH procedure by pressing the RTH button or Flight Pause button on the remote controller.

If the RTH procedure is cancelled following a low battery level warning, the Intelligent Flight Battery may not have enough charge for the aircraft to land safely, which may lead to the aircraft crashing or being lost. The thresholds for the battery level warnings are automatically determined based on the aircraft's current altitude and distance from the Home Point.

The aircraft will land automatically if the current battery level can only support the aircraft long enough to descend from its current altitude. The user cannot cancel the auto landing but can use the remote controller to alter the aircraft's orientation during the landing process.

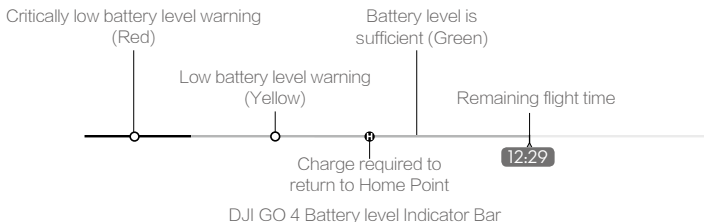



- The colored zones and markers on the DJI GO 4 battery level indicator bar reflect the estimated remaining flight time. They automatically adjust according to the aircraft's current location and status.
- If the current battery level can only support the aircraft long enough to descend from its current altitude, a critically low battery level warning triggers and the aircraft descends and lands automatically. This procedure cannot be canceled. If there is a danger of a collision, push the throttle up and try to navigate away.
- If the battery level is sufficient, the battery level indicator bar in DJI GO 4 displays the estimated remaining flight time based on the current battery level.

If a battery level warning appears, take action as described in the table below.

RTH and Battery Level Warnings (when using firmware v00.06.00.00 by default)

Warning	Aircraft Status Indicator	DJI GO 4 App	Remarks/Instructions
Low Battery	Blinks red slowly	Provides the option to return to the Home Point automatically or to resume normal flight. If no action is taken, the aircraft will automatically fly home after 10 seconds.	Battery level is low. Fly the aircraft back and land promptly, then stop the motors and replace the battery.
Critically Low Battery Level	Blinks red quickly	Display flashes red.	The aircraft descends and lands automatically. This procedure cannot be canceled. If there is a danger of a collision, push the throttle up and try to navigate away.

RTH and Battery Level Warnings (when using updated firmware v01.00.00.00)

Warning	Instructions	Aircraft Status Indicator	DJI GO 4 App	Actions
Low Battery Level	Remaining battery level supports RTH.	Blinks red slowly	Choose RTH or resume normal flight.	Select an option. If no action is taken, the aircraft will enter RTH.
	Remaining battery level supports Emergency RTH (when in RTH, with a normal RC signal, and at an altitude higher than 50 m).		Choose Emergency RTH or resume RTH.	Select an option. Emergency RTH (aircraft descends to 50 m and returns to the Home Point) or resume RTH (aircraft flies to Home Point without descending). If no action is taken, the aircraft will enter Emergency RTH.
	Remaining battery level supports Emergency Landing (when in RTH with a normal RC signal).		Aircraft lands. Action cannot be canceled.	Aircraft lands immediately.
Critically Low Battery Level	Aircraft lands after 10 seconds (when flying normally with a critical low battery level).	Blinks red quickly	Aircraft lands after 10 seconds. Action cannot be canceled.	Aircraft lands after 10 seconds.
	Aircraft lands automatically (when flying normally with an extremely critical low battery level).		Aircraft lands immediately. Action cannot be canceled.	Aircraft lands immediately.

Failsafe RTH

The Forward Vision System allows the aircraft to create a real-time map of its flight route as it flies. If the Home Point was successfully recorded and the compass is functioning normally, Failsafe RTH automatically activates after the remote control signal is lost for more than two seconds.

When Failsafe RTH is activated, the aircraft starts to retrace its original flight route home. If the wireless control signal is re-established within 60 seconds of Failsafe RTH being activated, the aircraft hovers at its present location for 10 seconds and waits for pilot commands. The user may tap  in the DJI GO 4 app or press the RTH button on the remote controller to cancel Failsafe RTH and retake control. If no pilot command is given, the aircraft flies to the Home Point in a straight line. If the wireless control signal is still lost 60 seconds after activating Failsafe RTH, the aircraft stops retracing its original flight route and flies to Home Point in a straight line.

RTH Procedure

Smart RTH, Low Battery RTH, and Failsafe RTH all follow the RTH procedure:

1. The aircraft adjusts its orientation.
2. a. If the aircraft is further than 20 m from the Home Point, it ascends to the pre-set RTH altitude and then flies to the Home Point at a speed of 12 m/s. If the current altitude is higher than the RTH altitude, the aircraft flies to the Home Point at the current altitude. Forward and Backward vision systems are enabled.
b. If the aircraft is between 5 m and 20 m from the Home Point, it flies to the Home Point at the current altitude. If the current altitude is less than 2 m, the aircraft ascends to 2 m and then flies to the Home Point at a speed of 3 m/s.
c. If the aircraft is less than 5 m from the Home Point when the RTH procedure begins, it lands immediately.
3. After reaching the Home Point, the aircraft lands and the motors stop.

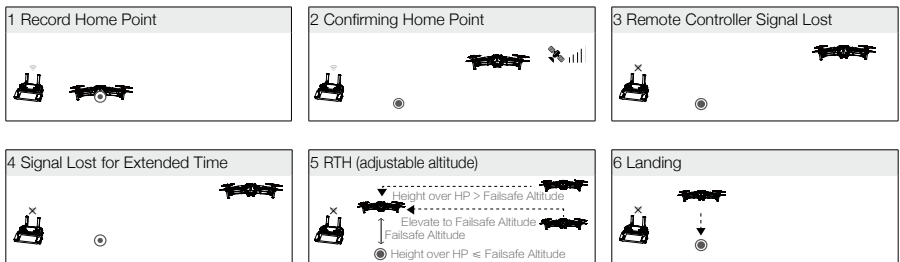

Obstacle Avoidance during RTH

Provided that lighting conditions are sufficient for the Forward and Backward Vision Systems to operate, the Mavic 2 Pro/Zoom senses and actively attempts to avoid obstacles during RTH. The obstacle avoidance procedure is as follows:

1. The aircraft decelerates when an obstacle is sensed.
2. The aircraft stops and hovers then ascends until no obstacle is sensed.
3. The RTH procedure resumes. The aircraft flies to the Home Point at the new altitude.

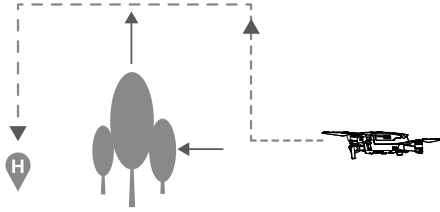

- The aircraft cannot return to the Home Point if the GPS signal is weak or if GPS is unavailable.
- In Smart RTH and Low Battery RTH, the aircraft automatically ascends to an altitude of 65 ft (20 m). Once the altitude is 65 ft (20 m) or higher, move the throttle stick and the aircraft stops ascending and flies to the Home Point at its current altitude.
- The aircraft cannot avoid obstacles during Failsafe RTH if the Forward and Backward Vision Systems are unavailable. It is important to set a suitable RTH Altitude before each flight. Launch the DJI GO 4 app, tap  and then set the RTH Altitude.
- During RTH, the aircraft's speed and altitude can be controlled using the remote controller or the DJI GO 4 app, but the flight controller controls its orientation and direction of flight.
- During RTH, obstacles on either side of the aircraft cannot be detected or avoided.

Landing Protection

Landing Protection activates during Smart RTH and the aircraft performs as follows:

1. When Landing Protection determines that the ground is suitable for landing, the aircraft lands gently.
2. If Landing Protection determines that the ground is not suitable for landing, the aircraft hovers and waits for the pilot to confirm it is suitable to land.
3. If Landing Protection is not operational, the DJI GO 4 app displays a landing prompt when the aircraft descends below 0.5 m. Pull down on the throttle for one second or use the auto landing slider in the app to land.

Landing Protection activates during Low Battery RTH and Failsafe RTH. The aircraft performs as follows:

During Low Battery RTH and Failsafe RTH, the aircraft hovers at 2 m above the ground and waits for the pilot to confirm it is suitable to land. Pull down on the throttle for one second or use the auto landing slider in the app to land. Landing Protection activates and the aircraft performs the steps listed above.



Vision Systems are disabled during landing. Be sure to land the aircraft with caution.

Vision Systems and Infrared Sensing Systems

The Mavic 2 Pro/Zoom is equipped with Forward, Backward, Downward, and Lateral Vision Systems, and Upward and Downward Infrared Sensing Systems, providing omnidirectional obstacle sensing (if lighting conditions are adequate).

The main components of the Forward, Backward, and Downward Vision Systems are six cameras located on the nose, rear side, and the underside of the aircraft. Lateral Vision Systems are two cameras located on either side of the aircraft.

The main components of the Upward and Downward Infrared Sensing Systems are two 3D infrared modules located on the upper and underside of the aircraft.

The Downward Vision System and Infrared Sensing System helps the aircraft maintain its current position and hover in place more precisely and to fly indoors or in other environments where a GPS signal is unavailable. In addition, the Auxiliary Bottom Light located on the underside of the aircraft improves visibility for the Downward Vision System in weak lighting conditions.

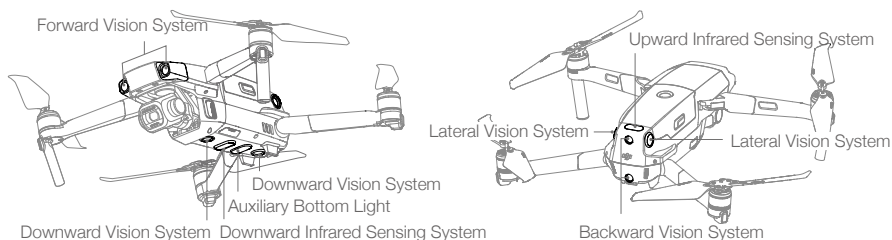

Detection Range

The detection range of the Vision Systems is depicted as followed. Please note that the aircraft cannot sense or avoid the obstacles that are not within detection range.

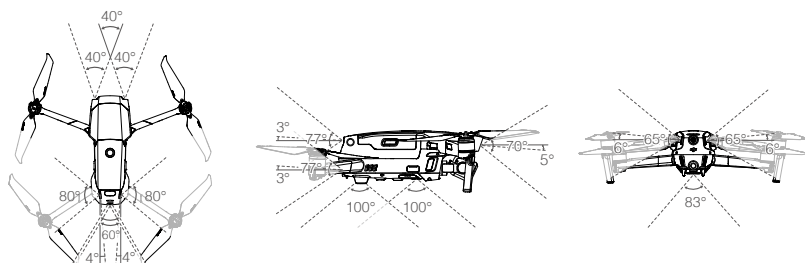

Calibrating Vision System Cameras

The Vision System cameras installed on the aircraft are factory calibrated. If the aircraft experiences a collision, however, it may require calibration via DJI Assistant 2 or DJI GO 4.

The most accurate way to calibrate the Vision System cameras is by using DJI Assistant 2. Follow the steps below to calibrate the Forward Vision System cameras, then repeat the steps to calibrate other Vision System cameras.

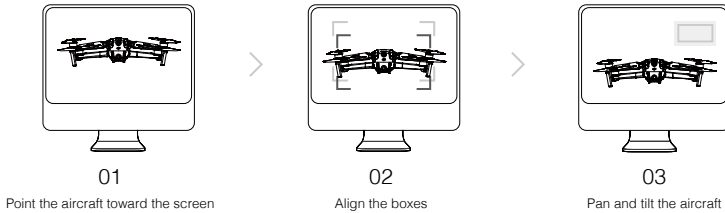

When a vision system calibration is required, DJI GO 4 sends a notification. If a computer is not nearby, however, a quick calibration can be performed in the app. Tap the Aircraft Status bar and Vision Sensors to start quick calibration.



- Quick calibration is only a quick fix for vision system issues. When possible, connect the aircraft to a computer to carry out a full calibration using DJI Assistant 2. Only calibrate on textured surfaces such as grass or when lighting conditions are adequate.
- Do not calibrate the aircraft on highly reflective surfaces such as marble or ceramic tiles.

Using the Vision Systems

The Downward Vision System and Infrared Sensing System activate automatically when the aircraft is turned on. No further action is required. When using the Downward Vision System, the aircraft can hover precisely even without GPS.

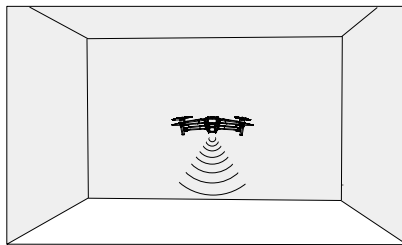

The Downward Vision System is typically used in indoor environments where GPS is unavailable. The Downward Vision System works best when the aircraft is at altitudes of 1.6 to 33 ft (0.5 to 11 m). Please note that the Vision Positioning function may be affected if the aircraft's altitude is above 33ft (11 m).

Follow the steps below to use the Downward Vision System:

1. Ensure the aircraft is in P-mode and place the aircraft on a flat surface. Please note that the Downward Vision System cannot work properly on surfaces without clear pattern variations.
2. Turn on the aircraft. The aircraft hovers in place after takeoff. The Aircraft Status Indicators flash green twice, which indicates the Downward Vision System is working.



Using the Forward and Backward Vision Systems, the aircraft can actively brake when detecting obstacles in front. The Forward and Backward Vision Systems work best with adequate lighting and clearly marked or textured obstacles. To allow for sufficient time to brake, the aircraft should not fly more than 31 mph (50 kph) when flying forward or more than 27 mph (42 kph) when flying backward.

The Lateral Vision Systems requires better lighting and more textured or clearly marked obstacles, and cannot sense dynamic objects, such as moving people, vehicles, tree branches, or blinking lights. Lateral Vision Systems are only available in ActiveTrack 2.0 and Tripod Mode. The angular speed is limited to 24° /s and the lateral flight speed is limited to 18 mph (29 mph).



- Lateral Vision Systems are only available in ActiveTrack 2.0 and Tripod Mode. Lateral Vision Systems have limited ability to sense and avoid obstacles, and the performance may be affected by the surrounding environment. Be sure to maintain line of sight with the aircraft and pay attention to prompts in DJI GO 4. DJI takes no responsibility for any aircraft that is damaged or lost while using Lateral Vision Systems.
 - The Vision System cannot work properly over surfaces that DO NOT have clear pattern variations. The Vision System is only effective when the aircraft is at an altitude of 0.5 to 50 meters. Please note that the Vision Positioning function may be affected if the aircraft's altitude is above 33 ft (11 m).
 - The Auxiliary Bottom Light is automatically enabled when the environment light is too weak. Please note that the Vision System cameras performance may be affected when the auxiliary bottom light is enabled. Fly with caution if the GPS signal is weak.
 - The Vision System may NOT function properly when the aircraft is flying over water or snow-covered areas.
 - Note that the Vision System may NOT function properly when the aircraft is flying too fast. Fly with caution when flying at over 10 m/s (32.8 ft/s) at 2 m (6.6 ft) or over 5m/s (16.4 ft) at 1 m (3.3 ft).
 - Operate the aircraft cautiously when in any of the following situations:
 - a. Flying over monochrome surfaces (e.g., pure black, pure white, pure green).
 - b. Flying over highly reflective surfaces.
 - c. Flying over water or transparent surfaces.
 - d. Flying over moving surfaces or objects.
 - e. Flying in an area where the lighting changes frequently or drastically.
 - f. Flying over extremely dark (< 10 lux) or bright (> 40,000 lux) surfaces.
 - g. Flying over surfaces that strongly reflect or absorb infrared waves (e.g., mirrors).
 - h. Flying over surfaces without clear patterns or texture.
 - i. Flying over surfaces with repeating identical patterns or textures (e.g., tiles with the same design).
 - j. Flying over obstacles with small surface areas (e.g., tree branches).
-



- Keep the sensors clean at all times. DO NOT tamper with the sensors. Do not obstruct the Infrared Sensing System.
- The Vision System may not be able to recognize patterns on the ground in low light conditions (less than 100 lux).
- If the aircraft speed exceeds 31 mph (50kph), the Vision System does not have enough time to brake and stop the aircraft at a safe distance from an obstacle.
- If the aircraft experiences a collision, camera calibration is required. Calibrate the front cameras if DJI GO 4 prompts you to do so.
- Do not fly on days that are rainy, smoggy, or if there is no clear sight.
- Check the following every time before takeoff:
 - a. Ensure there are no stickers or any other obstructions over the glass of the Infrared Sensing and Vision System.
 - b. If there is any dirt, dust, or water on the glass of the Infrared Sensing and Vision System, clean it with a soft cloth. Do not use any cleanser that contains alcohol.
 - c. Contact DJI Support if there is any damage to the glass of the Infrared Sensing and Vision System.
- The Upward Infrared Sensing System detects straight line distances, large obstacles such as roofs, but cannot detect tiny obstacles such as leaves or electrical wires.
- Do not obstruct the Downward Vision System and Downward Infrared Sensing System before takeoff. Otherwise, the aircraft cannot take off again after landing and will have to be restarted.

Intelligent Flight Modes

The Mavic 2 Pro/Zoom supports Intelligent Flight Modes including Hyperlapse, QuickShots, ActiveTrack 2.0, Point of Interest (POI 2.0), Waypoint (coming soon), TapFly, and Cinematic Mode. Select an Intelligent Flight Mode in DJI GO 4. Ensure the battery level is sufficient and the aircraft is working on P-mode when using the Intelligent Flight Modes.

Hyperlapse

Hyperlapse shooting modes include Free, Circle, Course Lock, and Waypoint.

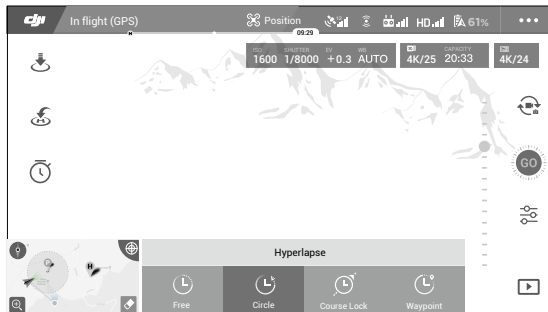

Free

The aircraft automatically takes photos and generates a timelapse video. Free mode can be used while the aircraft is on the ground. After takeoff, control the aircraft's altitude, flight speed, and gimbal angle using the remote controller. Hold the control sticks and accelerate at a steady speed for two seconds and then press the C1 button. The speed is fixed and the aircraft continues to travel at that speed while taking photos. The orientation of the aircraft can still be controlled during this time. Follow the steps below to use Free:

1. Set the interval time and video duration. The screen displays the number of photos that will be taken and how long the shooting time will be.
2. Tap the shutter button to begin.

Circle

The aircraft automatically takes photos while flying around the selected subject to generate a timelapse video. Circle can be selected to travel in either a clockwise or counter-clockwise direction. Please note that the aircraft exits from Circle if any command from the remote controller is received. Follow the steps below to use Circle:

1. Set the interval time and video duration. The screen displays the number of photos that will be taken and how long the shooting time will be.
2. Select a subject on the screen.
3. Tap the shutter button to begin.

CourseLock

With the Mavic 2 Pro/Zoom, Course Lock can be used in two ways. In the first way, the orientation of the aircraft is fixed, but a subject cannot be selected. In the second way, the orientation of the aircraft is fixed and the aircraft flies around a selected object. Follow the steps below to use Course Lock:

1. Set the interval time and video duration. The screen displays the number of photos that will be taken and how long the shooting time will be.
2. Set a flight direction.
3. Select a subject (if applicable).
4. Tap the shutter button to begin.

Waypoint

The aircraft automatically takes photos on a flight path of two to five waypoints and generates a timelapse video. The aircraft can fly in order from waypoint No. 1 to No. 5 or No. 5 to No. 1. Please note that the aircraft exits from Waypoints if any command from the remote controller is received. Follow the steps below to use Waypoint.

1. Set the desired waypoints and the lens direction.
2. Set the interval time and video duration. The screen displays the number of photos that will be taken and how long the shooting time will be.
3. Tap the shutter button to begin.

The aircraft will generate a timelapse video with resolution of 1080p25 automatically, which is viewable in the Playback menu. You can select to save the JPEG or RAW format footage and to store the footage in built-in storage or SD card in the camera settings.



- For optimal performance, it is recommended to use Hyperlapse at an altitude higher than 50 m and to set a difference of at least two seconds between the interval time and shutter..
- It is recommended to select a static subject (e.g., high-rise buildings, mountainous terrain) at a safe distance from the aircraft (further than 15 m). Do not select a subject that is too near the aircraft.
- The aircraft brakes and hovers in place if an obstacle is detected during Hyperlapse.
- The aircraft only generates a video if it has taken at least 25 photos, which is the amount required to generate a 1-second video. The video generates when a command is given from the remote controller or if the mode is exited unexpectedly (such as when the low battery RTH is triggered).

Task Library (Coming Soon)

Use Task Library to easily record flight paths, which can be repeated later.

QuickShots

QuickShot shooting modes include Dronie, Circle, Helix, Rocket, Boomerang, Asteroid, and Dolly Zoom (only available with Mavic 2 Zoom). The Mavic 2 Pro/Zoom records a video according to the selected shooting mode and then automatically generates a 10-second video. The video can then be viewed, edited, or shared to social media from Playback.



Dronie: The aircraft flies backward and ascends, with the camera locked on the subject.



Circle: The aircraft circles around the subject.



Helix: The aircraft ascends and spirals around the subject.



Rocket: The aircraft ascends with the camera pointing downward.



Boomerang: The aircraft flies around the subject in an oval path, ascending as it flies away from its starting point and descending as it flies back. The aircraft's starting point forms one end of the oval's long axis, while the other end of its long axis is at the opposite side of the subject from the starting point.

Ensure there is sufficient space when using Boomerang: Allow a radius of at least 99 ft (30 m) around the aircraft and allow at least 33 ft (10 m) above the aircraft.



Asteroid: The aircraft flies backward and upward and then takes several photos, then flies back to its starting point. The video generated starts with a panorama of the highest position and then shows the descent. Ensure there is sufficient space when using Asteroid: Allow at least 132 ft (40 m) behind and 164 ft (50 m) above the aircraft.



Dolly Zoom: The Mavic 2 Zoom flies backward and upward. It adjusts the zoom during flight to keep the selected subject the same while the background changes.

When planning to use Dolly Zoom, first select the distance between the aircraft and subject. Be sure that there is at least three times that distance available on the rear side of the aircraft so that there is sufficient space to fly.

Using QuickShots

Ensure that the aircraft is in P-mode and that the Intelligent Flight Battery is sufficiently charged.

Follow the steps below to use QuickShots:

1. Take off and hover at least 6.6 ft (2 m) above the ground.

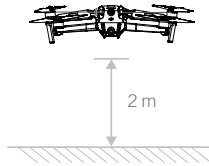



2. In DJI GO 4, tap , then select QuickShots and follow the prompts.



3. Select your target subject in Camera View (tap the circle on the subject or drag a box around the subject) and choose a shooting mode. Tap "GO" to begin recording. The aircraft flies back to its original position once shooting is finished.
4. Tap  to access the video.

Exiting QuickShots

Toggle the Flight Mode switch to S-mode or T-mode to exit QuickShots anytime during shooting (when Multiple Flight Modes is enabled in the DJI GO 4 app). Press the Flight Pause button on the remote controller or tap  in DJI GO 4 or for the emergency brake.

-  Please use this function at locations that are clear of buildings and other obstacles. Make sure that there is no human, animals or other obstacles on the flight path. The aircraft will brake and hover in place when an obstacle is detected.
- Always pay attention to objects around the aircraft and use the remote control device to avoid accidents (such as collisions) or occlusion with the aircraft.
- Be extra cautious when using QuickShot in any of the following situations:
 - a. When the shoot subject is blocked for a long time or outside the line of sight;
 - b. When the shoot subject is more than 50 m away from the aircraft;
 - c. When the shoot subject is similar in color or patterns with the surrounding;
 - d. When the shoot subject is in the air;
 - e. When the shoot subject moves fast;
 - f. The lighting is extremely low (< 300 lux) or high (> 10,000 lux).
- DO NOT use QuickShot in places that are close to buildings or the GPS signal is weak, to avoid unstable flight path.
- You must follow local privacy laws and regulations when using QuickShot.
- Note that the lateral vision system is unavailable during QuickShot.

ActiveTrack 2.0

ActiveTrack 2.0 allows you to select an object on your mobile device screen. The aircraft adjusts its flight to track the subject. No external tracking device is required. Mavic 2 Pro/Zoom can automatically identify up to 16 objects and uses different tracking strategies to track people, vehicles, and boats.

Using ActiveTrack 2.0

Ensure that the aircraft is in P-mode and that the Intelligent Flight Battery is sufficiently charged. Follow the steps below to use ActiveTrack 2.0:

1. Take off and hover at least 6.6 ft (2 m) above the ground.

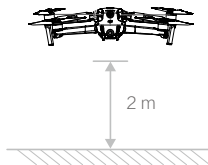

2. In DJI GO 4, tap , then select ActiveTrack 2.0.

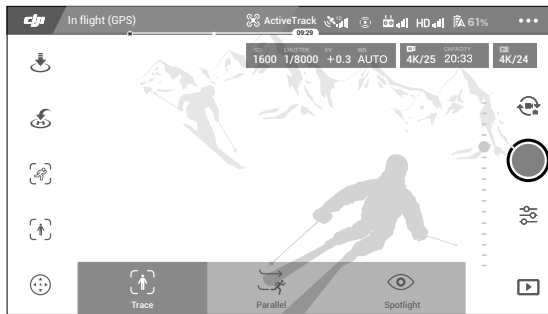

3. For optimal performance, it is recommended to select a subject that is automatically recognized by the aircraft. To do so, select a subject that has been recognized onscreen and tap to confirm your selection. If the desired subject has not been recognized by the aircraft, drag a selection around it onscreen and tap to select it manually. When the subject is selected manually, however, the ability of the aircraft to track the subject may be affected. If the box turns red, the object cannot be identified and it needs to be selected again.
4. The aircraft automatically avoids obstacles in its flight path. If the aircraft loses track of the subject because it is moving too fast or is obscured, re-select the subject to resume tracking.

ActiveTrack 2.0 includes the following sub-modes:

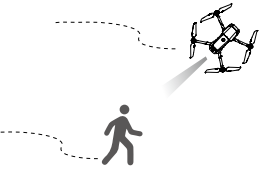
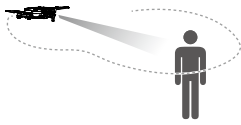
Trace	Parallel	Spotlight
		
<p>The aircraft tracks the subject at a constant distance. Use the roll stick and tilt stick on the remote controller to change the distance, and use the slider in DJI GO 4 to fly in a circle around the subject. The framing of the subject is adjusted using the left stick and gimbal dial.</p> <p>When detecting an obstacle in this sub-mode, the aircraft will behave as follows:</p> <ol style="list-style-type: none"> 1. If any action is performed on the remote controller after an obstacle is detected, the aircraft brakes and hovers in place. 2. If no action is taken, the aircraft tries to avoid the obstacle. 	<p>The aircraft tracks the subject at a constant angle and distance from the front and side. Use the roll stick on the remote control to fly in a circle around the subject. The framing of the subject is adjusted using the left stick and gimbal dial.</p> <p>In this sub-mode, the aircraft brakes and hovers in place once an obstacle is detected.</p>	<p>The aircraft does not track a subject automatically, but keeps the camera pointed in the direction of the subject during flight. The remote controller is used to maneuver the aircraft, but control of orientation is disabled. The framing of the subject is adjusted using the left stick and gimbal dial. The aircraft brakes immediately when an obstacle is detected in this sub-mode.</p>



- DO NOT use ActiveTrack 2.0 in areas with people, animals, small or fine objects (e.g., tree branches or power lines), or transparent objects (e.g., water or glass).
- Operate the aircraft manually (press the Flight Pause button or toggle the Flight Mode switch to S-mode on the remote controller) or tap  in DJI GO 4 in an emergency.
- Be extra vigilant when using ActiveTrack 2.0 in any of the following situations:
 - a. The tracked subject is not moving on a level plane.
 - b. The tracked subject changes shape drastically while moving.
 - c. The tracked subject is out of sight for an extended period.
 - d. The tracked subject is moving on a snowy surface.
 - e. The tracked subject has a similar color or pattern to its surrounding environment.
 - f. Available light is too low (< 300 lux) or too high (> 10,000 lux).
- You must follow local privacy laws and regulations when using ActiveTrack 2.0.
- It is recommended to only track people (but not recommended to track children), vehicles, and boats. Fly with caution when tracking other subjects.
- The tracking subject may inadvertently swap to another subject if they pass nearby to each other.
- There are two options when selecting the tracking speed limit. Safe mode limits the speed to no more than 12 m/s and Max mode to no more than 20 m/s. Please note that the aircraft cannot avoid obstacles if the speed exceeds 12 m/s.

Exiting ActiveTrack 2.0

Press the Flight Pause button on the remote controller to brake immediately. Tap  on the screen or toggle the Flight Mode switch to S-mode on the remote controller to exit ActiveTrack 2.0. After exiting ActiveTrack 2.0, the aircraft hovers in place, at which point you may choose to fly manually, track another subject, or return to home.

Point of Interest 2.0 (POI 2.0)

Select a static subject as the Point of Interest. Set the circle radius, flight altitude, and flight speed. The aircraft flies around the subject according to these settings. Mavic 2 Pro/Zoom supports selecting the POI through GPS positioning and selecting on the screen directly.

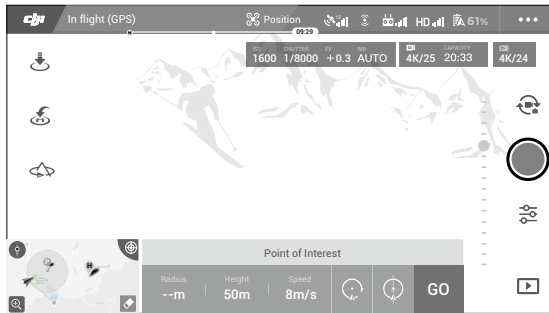

1. Select POI on the screen: drag a box around the desired subject and tap the “GO” icon on the screen. The aircraft starts to measure the location of the subject and flies around the subject once it measures the location successfully. Use the gimbal dial to adjust the subject framing. The circle radius, flight altitude, and flight speed can also be adjusted during flight.



- It is recommended to select a static subject (e.g., high-rise buildings, mountainous terrain) at a safe distance from the aircraft (further than 10 m). Do not select a subject that is too near the aircraft.
- Avoid selecting a subject without a clear pattern (e.g., a clear blue sky).
- Avoid selecting subjects that are too small.
- Select a subject with a clear outline. Otherwise, the subject may not be centered correctly onscreen.
- The aircraft cannot be controlled while the location is being measured, but the measuring can be stopped using the control sticks, Flight Pause button, Flight Mode switch, and the “STOP” icon.

2. Select a subject through GPS positioning: Manually fly the aircraft above the subject, and then press the C1 button or select in DJI GO 4 to confirm the subject. Fly the aircraft at least 5 m away from the Point of Interest. The flight speed and the circle direction can be set in DJI GO 4. Tap “GO” to start flying. Use the gimbal dial to adjust the subject framing. The circle radius, flight altitude, and flight speed can also be adjusted during flight.



- The GPS positioning has no altitude measurement.
- It is recommended to adjust the gimbal tilt to -90° to make it easier to measure the GPS location.

Flight Parameter Settings

1. Flight Speed: Flight speed range is 0-10 m/s, the "+" value means the aircraft circles the point counter-clockwise, and the "-" value means the aircraft circles the point clockwise. Adjust the speed by sliding the onscreen slider, and use the roll stick on the remote controller to increase the value.
2. Circle Radius: Adjust the radius by sliding the onscreen slider, and use the tilt stick on the remote controller to increase the value.
3. Circle Attitude: Adjust the attitude by sliding the onscreen slider, and use the throttle stick on the remote controller to increase the value.
4. Gimbal Angle: Use the yaw stick to control the gimbal's yaw, and use the gimbal dial to control the gimbal's tilt. Tap the icon to recenter the gimbal (If GPS Positioning is used to select the Point of Interest, only the yaw recenters. If the Point of Interest is selected on the screen, both the yaw and tilt recenter).
5. Circle Direction: Select the direction by sliding the onscreen button.

Exiting Point of Interest

Tap  on the screen or press the Flight Pause button to pause the Point of Interest mode. Press and hold on the Flight Pause button to exit Point of Interest mode.



- The aircraft brakes and hovers in place once an obstacle is detected during POI.
 - If the aircraft nose is aimed towards the Point of Interest during flight, the aircraft may not be able to avoid obstacles. Use Point of Interest in a wide open area.
-

Waypoints (Coming Soon)

The aircraft flies to the waypoints in order according to the settings. The flight orientation and speed can be controlled during flight. You can select the waypoints by flying the Mavic 2 Pro/Zoom to the waypoints and record them individually. The waypoints can also be selected and edited in the map before takeoff:

1. Add Waypoints and Point of Interest in the map. The aircraft's camera points to the Point of Interest when traveling through the waypoints.
2. Tap on the Waypoints and Point of Interest to set the altitude, flight speed, and other parameters.
3. Drag the Waypoints and Point of Interest to adjust the positions.
4. Flight speed, failsafe settings, and aircraft behavior can be configured after completing the Waypoints.
5. Waypoints and Point of Interest information can be saved in the app while editing in the map and the flight path can be recorded and repeated.



- In challenging environments such as those surrounded by high-rise buildings it is recommended to set waypoints by flying to each waypoint manually.
-

TapFly

TapFly features three sub-modes; Forward, Backward, and Free. Providing that lighting conditions are suitable, the aircraft automatically avoids obstacles it senses.

Forward: The aircraft flies towards the target with the Forward Vision System sensing obstacles.

Backward: The aircraft flies in the opposite direction of the target with the Backward Vision System sensing obstacles.

Free: The aircraft flies towards the target. The remote controller can be used to maneuver the orientation of the aircraft freely. The aircraft cannot avoid obstacles in this mode. Fly with caution.

Using TapFly

Ensure that the aircraft is in P-mode and that the Intelligent Flight Battery is sufficiently charged. Follow the steps below to use TapFly:

1. Take off and hover at least 3.3 ft (1 m) above the ground.

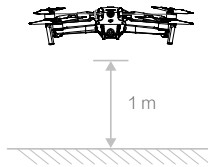

2. In DJI GO 4, tap , select TapFly, then select a sub-mode and follow the prompts.

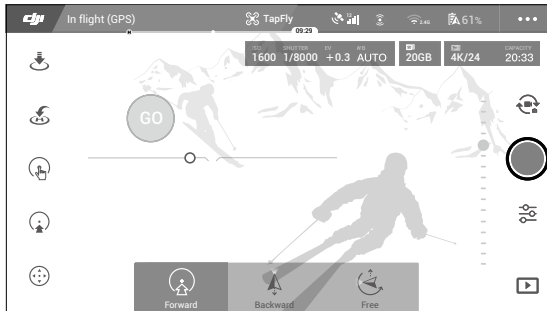

3. Tap on the target and wait for "GO" to appear. Tap "GO" to confirm the selection and the aircraft flies to the target automatically. A prompt appears if the target cannot be reached. If this is the case, select another target and try again. The target can be changed midflight by tapping the screen.

Exiting TapFly

Press the Flight Pause button on the remote controller or pull a control stick in the direction opposite to the direction of flight and the aircraft brakes and hovers in place. Tap the screen to resume TapFly. Tap  or toggle the Flight Mode switch to S-mode to exit TapFly.





- DO NOT use TapFly in areas with people, animals, small or fine objects (e.g., tree branches or power lines), or transparent objects (e.g., water or glass). TapFly may not work properly when the aircraft is flying over water or snow-covered areas.
 - There may be deviations between expected and actual flight paths selected in TapFly.
 - The selectable range for the target direction is limited. You cannot make a selection close to the upper or lower edges of the screen.
-

Cinematic Mode

Tap in DJI GO 4 to select Cinematic mode. In Cinematic mode, the aircraft's braking distance is extended and its rotation speed is reduced. The aircraft slows down gently until it stops, keeping footage smooth and stable even if control inputs are choppy.

Advanced Pilot Assistance Systems

The Advanced Pilot Assistance Systems (APAS) feature is available in P-mode. When APAS is enabled, the aircraft continues to respond to user commands and plans its path according to both control stick inputs and the flight environment. APAS makes it easier to avoid obstacles, obtain smoother footage, and gives a better flying experience.

When APAS is enabled, pressing the Flight Pause button on the remote controller or tapping  in DJI GO 4 brings the aircraft to a stop. The aircraft hovers for three seconds and awaits pilot commands. To enable APAS, tap  in DJI GO 4.



- The APAS feature is automatically disabled when using Intelligent Flight Modes and resumes automatically after exiting Intelligent Flight Modes.
 - The APAS feature is only available when flying forward and backward. If the aircraft flies left or right, APAS is disabled.
 - The aircraft hovers in place once there is an obstacle that cannot be avoided. The aircraft cannot detect and avoid obstacles that are beneath it.
 - Make sure you use the Advanced Pilot Assistance System (APAS) when the Vision Systems are available. Ensure there are no people, animals, small or subtle objects (e.g., tree branches, power lines) or transparent objects (e.g., glass, water) along the desired flight path.
 - APAS may not function properly when the aircraft is flying over water or snow-covered area.
 - Be extra cautious when flying in extremely dark (< 300 lux) or bright (> 10,000 lux) environments.
 - APAS may not function properly when the aircraft is flying near its Flight Limits or in No-fly Zones.
 - Pay attention to the Aircraft Status Bar in DJI GO 4 and ensure the aircraft is working in APAS mode normally.
-

Flight Recorder

Flight data including flight telemetry, aircraft status information, and other parameters are automatically saved to the aircraft's internal data recorder. The data can be accessed using DJI Assistant 2.

Attaching and Detaching the Propellers

The Mavic 2 Pro/Zoom use low-noise propellers. There are two varieties of the propellers, which are designed to spin in different directions. White marks are used to indicate which propellers should be attached to which motors.

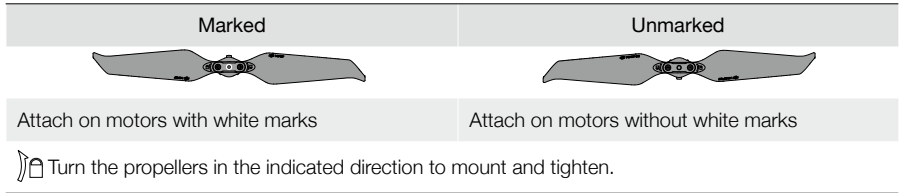

Attaching the Propellers

Attach the propellers with the white marks to the motors with white marks and the unmarked propellers to the motors without marks. Press each propeller down onto the motor and turn until it is secure.

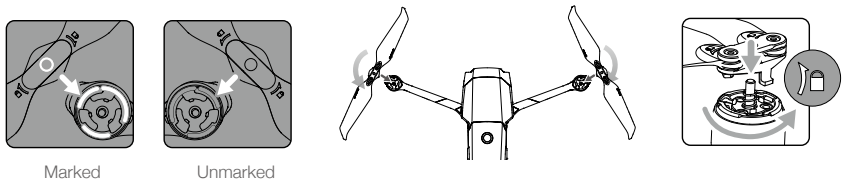

Detaching the Propellers

Press the propellers down onto the motors and rotate them in the unlock direction.



- Propeller blades are sharp. Handle with care.
- Only use original DJI propellers. Do not mix propeller types.
- Ensure that all propellers are in good condition before each flight. Do not use aged, chipped, or broken propellers.
- Ensure that the propellers and motors are installed securely before each flight.
- To avoid injury, stand clear of and do not touch propellers or motors when they are spinning.
- To avoid damaging the propellers, place the aircraft in the direction shown in the carrying case during transportation or storage. Do not squeeze or bend the propellers. If propellers are damaged, the flight performance is affected.
- Ensure the motors are mounted securely and rotating smoothly. Land the aircraft immediately if a motor is stuck and unable to rotate freely.
- Keep the motors free of dust.
- DO NOT attempt to modify the structure of the motors.
- DO NOT touch or let your hands or body come in contact with the motors after flight as they may be hot.
- DO NOT block any of the ventilation holes on the motors or the body of the aircraft.
- Ensure the ESCs sound normal when powered on.

Intelligent Flight Battery

The Mavic 2 Intelligent Flight Battery is a 15.4 V, 3850 mAh battery with smart charging/discharging functionality. Only use a DJI approved AC power adapter to charge the battery.

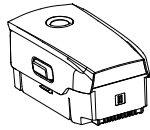

Intelligent Flight Battery

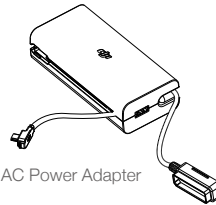

AC Power Adapter

Battery Features

1. **Battery Level Display:** The LED indicators display the current battery level.
2. **Auto-Discharging Function:** To prevent swelling, the battery automatically discharges to less than 60% of the maximum battery level when it is idle for more than 10 days. It takes approximately three to four days to discharge the battery to 65%. It is normal to feel moderate heat being emitted from the battery during the discharging process.
3. **Balanced Charging:** During charging, the voltages of the battery cells are automatically balanced.
4. **Overcharge Protection:** The battery stops charging automatically once fully charged.
5. **Temperature Detection:** The battery only charges when the temperature is between 41° and 104° F (5° and 40° C).
6. **Overcurrent Protection:** The battery stops charging if an excess current is detected.
7. **Over-discharge Protection:** Discharging stops automatically to prevent excess discharge.
8. **Short Circuit Protection:** The power supply is automatically cut if a short circuit is detected.
9. **Battery Cell Damage Protection:** DJI GO 4 displays a warning message when a damaged battery cell is detected.
10. **Hibernation Mode:** The battery switches off after 20 minutes of inactivity to save power. If the battery level is less than 10%, the battery enters Hibernation mode to prevent over-discharge. In Hibernation mode, the battery level indicators do not illuminate. Charge the battery to wake it from hibernation.
11. **Communication:** Information about the battery's voltage, capacity, and current is transmitted to the aircraft.



Refer to the Mavic 2 Intelligent Flight Battery Safety Guidelines before use. Users take full responsibility for all operations and usage.

Using the Battery

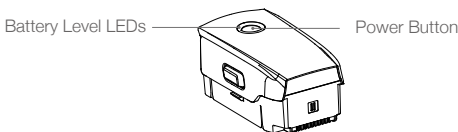

Checking Battery Level

The battery level LEDs display how much charge remains. If the battery is turned off, press the Power button, and the battery level LEDs light up to display the current battery level.

Powering On/Off

Press the Power button once, then press again, and hold for two seconds to turn the battery on or off.

Low Temperature Notice

1. Battery capacity is significantly reduced when flying in low-temperature environments of 14° to 41° F (-10° to 5° C). It is recommended to hover the aircraft in place for a while to heat the battery. Ensure to fully charge the battery before takeoff.
2. Batteries cannot be used in extremely low-temperature environments of < 14° F (-10° C).
3. When in low-temperature environments, end the flight as soon as DJI GO 4 displays the low battery level warning.
4. To ensure optimal performance of the battery, keep the battery temperature above 68° F (20° C).
5. The reduced battery capacity in low-temperature environments reduces the aircraft's wind speed resistance performance. Please fly with caution.
6. Fly with extra caution at a high sea level.

⚠ In cold environments, insert the battery into the battery compartment and turn on the aircraft for approximately 1 to 2 minutes to warm up before taking off.

Charging the Battery

Fully charge the Intelligent Flight Battery before using for the first time:

1. Connect the AC power adapter to a power source (100-240 V, 50/60 Hz).
2. Attach the Intelligent Flight Battery to the AC power adapter using the battery charging cable with the battery powered off.
3. The battery level LEDs display the current battery level during charging.
4. The Intelligent Flight Battery is fully charged when the battery level LEDs are all turned off. Detach the AC power adapter when the battery is fully charged.

Charging Time: 1 hour and 30 minutes.

-
- ⚠**
- DO NOT charge an Intelligent Flight Battery immediately after flight as the temperature may be too high. Wait until it cools down to room temperature before charging again.
 - The AC power adapter stops charging the battery if the battery cell temperature is not within the operating range of 41° to 104° F (5° to 40° C). The ideal charging temperature is 71.6° to 82.4° F (22° to 28° C).
 - The Battery Charging Hub (not included) can charge up to four batteries. Please visit the official DJI Online Store to learn more.
-

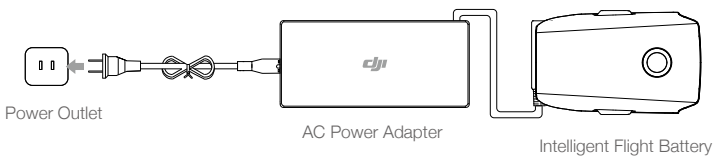

Battery Level LEDs During Charging

	LED1	LED2	LED3	LED4
Battery Level LEDs During Charging				
Battery Level	0%~25%	25%~50%	50%~75%	Fully Charged

Battery Protection

Battery Protection Mechanisms					
LED1	LED2	LED3	LED4	Blinking Pattern	Battery Protection Item
				LED2 blinks twice per second	Overcurrent detected
				LED2 blinks three times per second	Short circuit detected
				LED3 blinks twice per second	Overcharge detected
				LED3 blinks three times per second	Over-voltage charger detected
				LED4 blinks twice per second	Charging temperature is too low
				LED4 blinks three times per second	Charging temperature is too high

Inserting the Intelligent Flight Battery

Insert the Intelligent Flight Battery into the aircraft's battery compartment. Make sure it is mounted securely and that the battery latches have clicked into place.

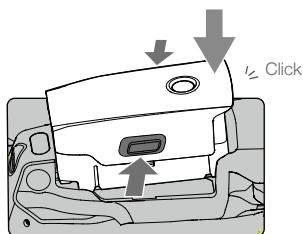

Removing the Intelligent Flight Battery

Slide the battery latches on the sides of the Intelligent Flight Battery to open the battery compartment.

- Never insert or remove the battery while it is turned on.
- Ensure the battery is mounted securely.

Gimbal and Camera

Gimbal

The Mavic 2 Pro/Zoom 3-axis gimbal provides stabilization for the camera, allowing you to capture clear and stable images and video. The gimbal has a tilt range of -90° to $+30^{\circ}$. Gimbal settings such as Gimbal Mode and Gimbal Auto Calibration can be selected by tapping .

Use the gimbal dial on the remote controller to control the camera's tilt. Alternatively, enter Camera View in DJI GO 4. Press the screen until a blue circle appears and drag the circle up and down to control camera tilt. Dragging the circle left and right controls the aircraft's orientation.

Gimbal Operation Modes

Two gimbal operation modes are available. Switch between the different operation modes on the camera settings page of DJI GO 4.

Follow Mode: The angle between the gimbal's orientation and aircraft's nose remains constant at all times.

FPV Mode: The gimbal synchronizes with the movement of the aircraft to provide a first-person perspective flying experience.

-
-  • When the aircraft is powered on, do not tap or knock the gimbal. To protect the gimbal during takeoff, always take off from open and flat ground.
- Precision elements in the gimbal may be damaged in a collision or impact, which may cause the gimbal to function abnormally.
 - Avoid getting dust or sand on the gimbal, especially in the gimbal motors.
 - A gimbal motor error may occur in the following situations:
 - a. The aircraft is on uneven ground or the gimbal's motion is obstructed.
 - b. The gimbal experiences excessive external force, such as during a collision.
 - DO NOT apply external force to the gimbal after the gimbal is powered on. DO NOT add any extra payload to the gimbal as this may cause the gimbal to function abnormally or even lead to permanent motor damage.
 - Make sure to remove the gimbal cover before powering on the aircraft. Also, make sure to mount the gimbal cover when the aircraft is not in use.
 - Flying in heavy fog or clouds may make the gimbal wet, leading to temporary failure. The gimbal recovers full functionality once it dries.
-

Camera

The Mavic 2 Pro uses a 1" CMOS sensor camera (jointly developed by DJI and Hasselblad), which features a lens with an adjustable aperture with a range of F2.8-F11. The camera supports auto focus, which can focus at 1 m to infinity. The filters on the camera can also be replaced. The Mavic 2 Pro camera shoots up to 4K30fps video and 20 MP photos, supports shooting modes such as Single shot, Burst shooting, Interval, Panorama, Slow motion, and Enhanced HDR.

The Mavic 2 Zoom uses a 1/2.3" CMOS sensor camera, supports 2x optical zoom, and the lens is 24-48 mm (35 mm format equivalent). The camera supports auto focus, which can focus at 0.5 m to infinity. The camera also supports replacing filters. The Mavic 2 Zoom camera shoots up to 4K30fps video and 12-megapixel photos, supports shooting modes such as Single shot, Burst shooting, Interval, Panorama, Slow motion and Enhanced HDR. Mavic 2 Zoom supports 2x optical zoom and 2x digital zoom when recording video in 1080p24/25/30.

- ⚠ • Ensure the temperature and humidity is suitable for the camera during usage and storage.
 - Use a lens cleanser to clean the lens to avoid damage.
 - DO NOT block any ventilation holes on the camera as the heat generated may damage the device and hurt the user.
-

Storing the Photos and Videos

The Mavic 2 Pro/Zoom comes with 8 GB of internal storage and also supports the use of a microSD card to store your photos and videos. A UHS-I Speed Grade 3 rating microSD card is required due to the fast read and write speeds necessary for high-resolution video data.

- ⚠ • Do not remove the microSD card from the aircraft while it is turned on. Otherwise, the microSD card may be damaged.
 - To ensure the stability of the camera system, single video recordings are limited to 30 minutes.
 - Check camera settings before use to ensure they are configured as desired.
 - Before shooting important pictures or videos, shoot a few images to test the camera is operating correctly.
 - Photos or videos cannot be transmitted or copied from the camera if the Intelligent Flight Battery is powered off.
 - Be sure to power off the Intelligent Flight Battery correctly. Otherwise, your camera parameters will NOT be saved and any recorded videos may be damaged. Note: Regardless of the reason, DJI is not responsible for any failure of an image or video to be recorded or having been recorded in a way that is not machine-readable.
-

Video Edit

The Mavic 2 Pro supports video formats MP4 and MOV, providing Normal, D-Log, and HLG color modes. In Normal mode, H.264 and H.265 code formats are supported. In D-Log or HLG mode, only H.265 is supported.

For the Mavic 2 Pro, Full FOV down samples from the 5.5K sensor to 4K resolution while HW crops in the center for finer image quality but less FOV. Full FOV view is 75° and HQ view is 55°. You can select between them according to your actual shooting demands.

Mavic 2 Zoom supports video formats MP4 and MOV, providing Normal and D-Cinelike color modes. H.264 and H.265 code formats are supported.

The software below has been tested by DJI and is recommended for playing or editing videos.

Software	Mac Version	Win Version
Adobe Premier Pro CC 2018	v12.1.1 (10)	v12.1.1 (10)
Davinci Resolve	v15.0 free	v14.3 Studio
Apple Final Cut Pro X	v10.4.3	/
Apple QuickTime	v10.4 (928.5.1)	/
Apple iMovie	v10.4.2	/
VLC Player	v3.0.2	v3.0.2

Remote Controller

This section describes the features of the remote controller and includes instructions for controlling the aircraft and the camera.

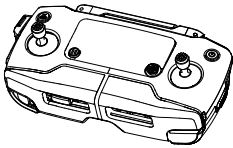

Remote Controller

Built into the remote controller is DJI's long-range transmission technology OcuSync 2.0, offering a maximum transmission range of 5 mi (8 km) and displaying video from the aircraft to DJI GO 4 on your mobile device at up to 1080p. Easily control the aircraft and camera using the onboard buttons. An onboard LCD screen gives real-time aircraft data information and the detachable control sticks make the remote controller easier to store.

In a wide-open area with no electromagnetic interference, OcuSync 2.0 smoothly transmits video links at up to 1080p, no matter how the flight attitude is changed. The remote controller works at both 2.4 GHz and 5.8 GHz, automatically selecting the best transmission channel. OcuSync 2.0 reduces the latency to 120-130 ms by improving the camera performance through the video decoding algorithm and the wireless link.

Auto Focus is supported during shooting even in low light conditions. The Mavic 2 Pro supports aperture and shutter adjustment and the Mavic 2 Zoom supports zoom in/out by using the Zoom Adjustment Dial.

The built-in battery has a capacity of 3950 mAh and a maximum run time of 2 hours and 15 minutes. The remote controller charges the mobile device with a charging ability of 500 mA@5V. The remote controller automatically charges Android devices. For iOS devices, first be sure that charging is enabled in DJI GO 4. Charging for iOS devices is disabled by default and needs to be enabled each time the remote controller is powered on.

Using the Remote Controller

Press the Power button to display the current battery level on the LCD screen. Press once, then again, and hold to turn the remote controller on or off.

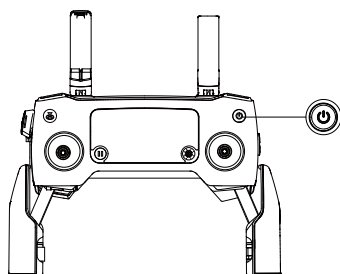

Charging the Battery

Connect the provided AC power adapter to the power port on the remote controller. It takes approximately 2 hours and 15 minutes to charge the remote controller battery fully. Remove the RC cable from the remote controller before charging.

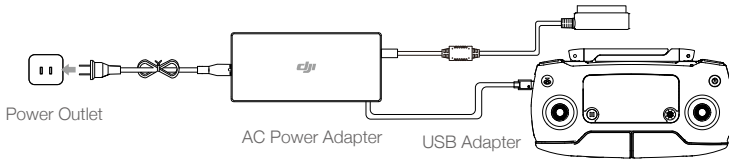

Controlling the Camera

Use the Aperture/Shutter Adjustment Dial to adjust the aperture and shutter parameters (Mavic 2 Pro only).

Use the Record button to start/stop recording.

Use the Focus/Shutter button to auto focus and take photos.

Use the Zoom Adjustment Dial to zoom in/out (Mavic 2 Zoom only).

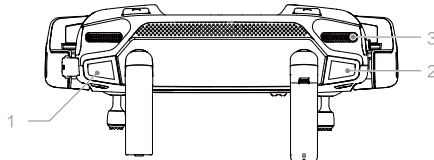

Controlling the Aircraft

The control sticks control the aircraft's orientation (yaw), forward/ backward movement (pitch), altitude (throttle), and left/right movement (roll). The control stick mode determines the function of each control stick movement. Three preprogrammed modes (Mode 1, Mode 2, and Mode 3) are available and custom modes can be configured in DJI GO 4. The default mode is Mode 2.

In each of the three pre-programmed modes, the Mavic 2 hovers in place at a constant orientation when both sticks are centered. Pushing a control stick away from the center position performs the functions shown in the figure below.

Mode 1

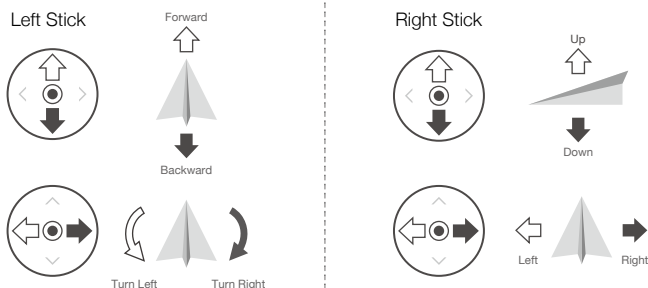



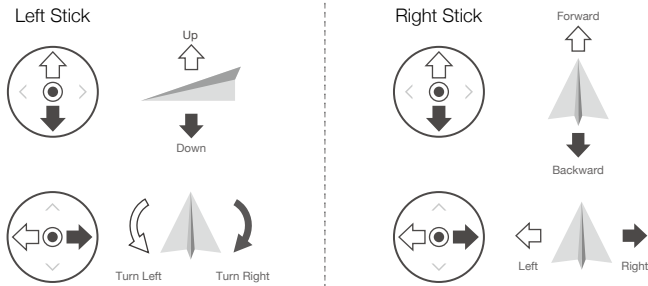

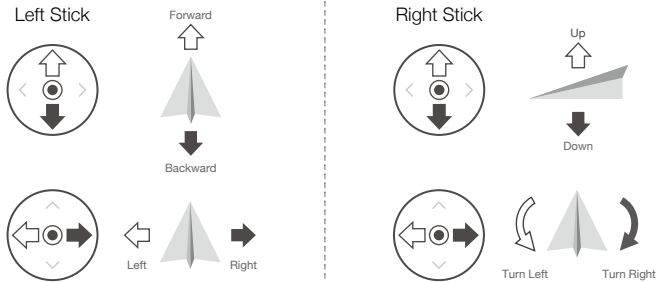

Mode 2

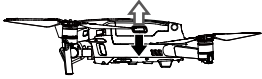

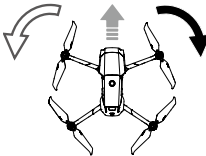
Mode 3



Remote Controller (Mode 2)	Aircraft (◀ Indicates Nose Direction)	Remarks
		<p>Moving the left stick up or down changes the aircraft's altitude. Push the stick up to ascend and down to descend. The more the stick is pushed away from the center position, the faster the aircraft will change altitude. Always push the stick gently to prevent sudden and unexpected changes in altitude.</p>
		<p>Moving the left stick to the left or right controls the orientation of the aircraft. Push the stick left to rotate the aircraft counter-clockwise and right to rotate the aircraft clockwise. The more the stick is pushed away from the center position, the faster the aircraft will rotate.</p>
		<p>Moving the right stick up and down changes the aircraft's pitch. Push the stick up to fly forward and down to fly backward. The more the stick is pushed away from the center position, the faster the aircraft will move.</p>
		<p>Moving the right stick to the left or right changes the aircraft's roll. Push the stick left to fly left and right to fly right. The more the stick is pushed away from the center position, the faster the aircraft will move.</p>





It is recommended to remove the control sticks and store in the storage slots on the remote controller during storage or transportation to avoid damage.

Flight Mode Switch

Toggle the switch to select the desired flight mode.

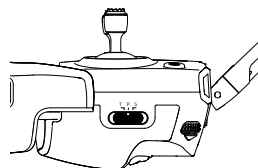
Position	Flight Mode
S	S-mode
P	P-mode
T	T-mode



Regardless of which position the switch is in on the remote controller, the Mavic 2 Pro/Zoom begins in P-mode by default. To switch flight modes, first go to Camera View in DJI GO 4, tap  and enable "Multiple Flight Modes". After enabling multiple flight modes, toggle the switch to P and then to S or T to switch flight modes.

RTH Button

Press and hold the RTH button to start the Return to Home (RTH) procedure where the aircraft returns to the last recorded Home Point. Press this button again to cancel RTH and regain control of the aircraft. Refer to the Return to Home section for more information about RTH.

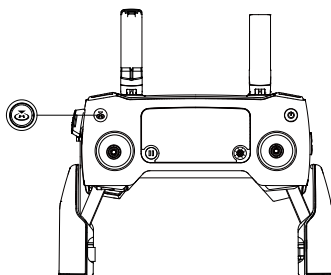

C1 and C2 Button

The functions of the C1 and C2 buttons are set in DJI GO 4. The default configuration for the C1 button is Center Focus and the default configuration for the C2 button is Playback. Remote Controller Alert
Remote controller will sound an alert during RTH or when the battery level is low. RTH Alert and low battery level (6% to 15%) alert can be canceled by pressing the power button once, and the critical battery level (less than 5%) alert can not be canceled.

Remote Controller Alert

Remote controller will sound an alert during RTH or when the battery level is low. RTH Alert and low battery level (6% to 15%) alert can be canceled by pressing the power button once, and the critical battery level (less than 5%) alert can not be canceled.

Optimal Transmission Zone

The signal between the aircraft and the remote controller is most reliable when the antennas are positioned in relation to the aircraft as depicted below.

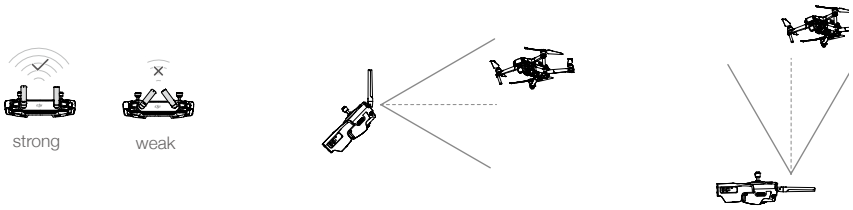

Ensure that the aircraft is flying within the optimal transmission zone. To maintain optimal transmission performance, adjust the remote controller and antennas according to the figure above.

LCD Screen

The LCD Screen displays various system statuses including real-time flight telemetry and battery levels. Refer to the figure below for the meaning of each icon on the LCD Screen.

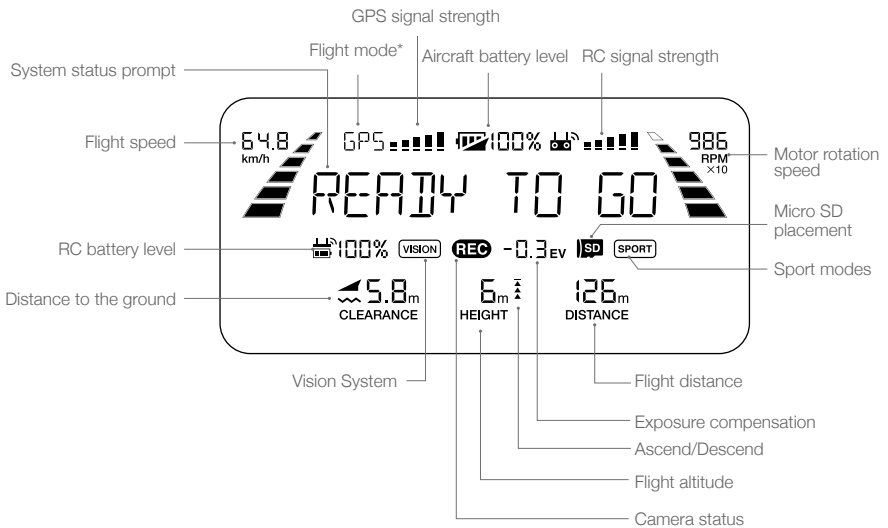

* On the remote controller's screen, the Primary remote controller displays "MCTL" while the Secondary remote controller will display the flight mode.

Dual Remote Controller Mode (Coming soon)

The Mavic 2 Pro/Zoom supports Dual Remote Controller Mode, which allows two remote controllers to connect to the same aircraft.

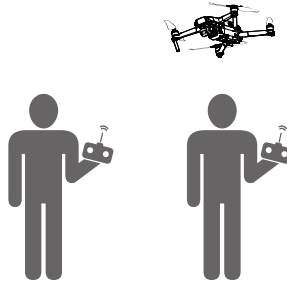

Both the Primary remote controller and the Secondary remote controller can control the orientation of the aircraft and the movement of the gimbal and camera operation.

Please note the different operations of the Primary and Secondary remote controller listed below.

1. Gimbal Dial

Both the Primary remote controller and the Secondary remote controller can control the gimbal dial, but the Primary remote controller has priority. For example, the Secondary remote controller is unable to control the gimbal dial when the Primary remote controller is using the gimbal dial. After the Primary remote controller has stopped controlling the gimbal dial for two seconds or more, the Secondary remote controller can control the gimbal dial.

2. Control Stick

Both the Primary remote controller and the Secondary remote controller can control the orientation of the aircraft using control sticks. The Primary remote controller has priority. The Secondary remote controller is unable to control the aircraft's orientation when the Primary remote controller is operating the control sticks. After the control sticks are idle for two seconds or more, the Secondary remote controller can control the aircraft's orientation.

If the control sticks on the Primary remote controller are pushed down and inward, the motors of the aircraft stop. If the same action is performed on the Secondary remote controller, however, the aircraft does not respond.

The control sticks on the Primary remote controller need to be released so that the Secondary remote controller can control the aircraft.

3. Flight Mode Switch

The flight mode can only be switched on the Primary remote controller. The Flight Mode Switch is disabled on the Secondary remote controller.

4. DJI GO 4 Settings

The display and parameter settings for the Primary and Secondary remote controllers in DJI GO 4 are the same. The Secondary remote controller can only configure the flight controller, vision system, video transmission, and Intelligent Flight Battery. Display and parameter settings for the Primary and Secondary remote controllers are the same in DJI GO 4.

Linking the Remote Controller

The remote controller is linked to your aircraft before delivery. Linking is only required when using a new remote controller for the first time. Follow these steps to link a new remote controller:

1. Power on the aircraft and the remote controller.
2. Launch DJI GO 4.
3. Enter “Camera” and tap on  and then tap the button to confirm. The remote controller is ready to link.
4. Locate the linking button on the side of the aircraft, as shown in the figure below. Press the link button to start linking. The Linking Status Indicator displays solid green once the remote controller successfully links to the aircraft, and the LCD screen on the remote controller displays the aircraft's information.

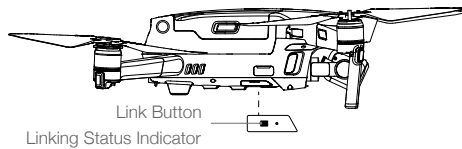

- Ensure the remote controller is within 1.6 ft (0.5 m) of the aircraft during linking.
- The remote controller will unlink itself from an aircraft if a new remote controller links to the same aircraft.
- In Dual Remote Controller Mode, the Secondary remote controller must also be relinked to the aircraft when the Primary remote controller is relinked to the aircraft.



- Fully charge the remote controller before each flight.
- If the remote controller is powered on and is NOT in use for five minutes, an alert will sound. After 10 minutes, it will automatically power off. Move the sticks to cancel the alert.
- Adjust the mobile device clamp to ensure the mobile device is secure.
- Ensure the antennas of the remote controller are unfolded and adjusted to the proper position to achieve optimal transmission quality.
- Repair or replace the remote controller if damaged. A damaged remote controller antenna greatly decreases performance.
- Fully charge the battery at least once every three months to maintain battery health.
- Ensure the control sticks are mounted securely.

DJI GO 4 App

This section introduces the main functions of the DJI GO 4 app.

DJI GO 4 App

Use this app to control the gimbal, camera, and other aircraft functions. The app features Equipment, Editor, SkyPixel, and Me sections, which are used for configuring your aircraft, and editing and sharing your photos and videos with others.

Equipment

Device Menu

If it is not already selected, select Mavic 2 Pro/Zoom from the device menu in the top left corner of the screen.

Function Menu

Tap  in the top right corner of the screen to open the Function menu. The menu has five options:

Scan QR Code: Scan a QR code to connect to an aircraft.

Academy: Use the flight simulator, watch tutorials, and read the product manuals.

Flight Records: Access all your flight records.

GEO Zones: Read information about GEO Zones.

Find My Drone: Get the map coordinates of your aircraft's last-recorded location and command the aircraft to blink its LEDs and make a beeping sound.

Camera View

Enter Camera View on the Equipment screen with your mobile device connected to the aircraft.

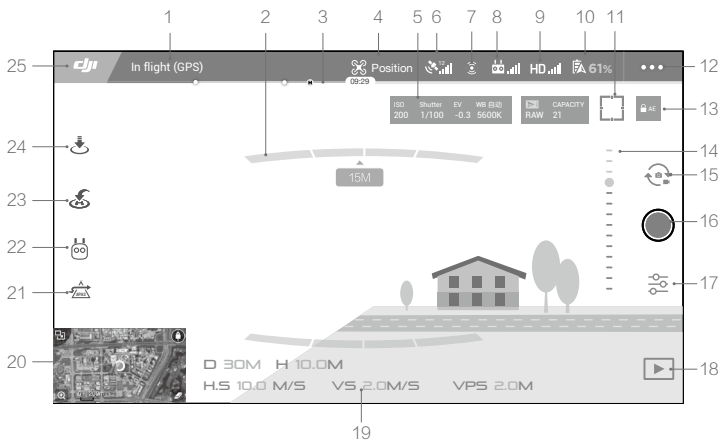

1. System Status Bar

 : This icon indicates aircraft flight status and displays various warning messages.

2. Obstacle Detection Status

 : Red bars display when obstacles are close to the aircraft. Orange bars display when obstacles are in the detection range.

3. Battery Level Indicator Bar

: The battery level indicator provides a dynamic display of the battery level. The colored zones on the battery level indicator represent the power levels needed to carry out different functions.

4. Flight Mode

: The text next to this icon indicates the current flight mode.

Tap to configure the Flight Controller settings. These settings allow you to modify flight limits and set gain values.

5. Camera Parameters

Displays camera parameters and the capacity of the internal storage and the microSD card.



Mavic 2 Pro:

Displays camera parameters and the capacity of the internal storage and the microSD card. Also displays camera focus mode, AE value, and focus parameters.

Mavic 2 Zoom:

Displays camera parameters and the capacity of the internal storage and the microSD card. Also displays focus parameters.

6. GPS Signal Strength

: Shows the current GPS signal strength. White bars indicate adequate GPS strength.

7. Vision Systems Status

: Tap this button to enable or disable features provided by the Vision Systems, and it displays the status for all vision systems. Icon in green indicates the corresponding vision system is available. Icon in red indicates the corresponding vision system is unavailable.

8. Remote Controller Signal

: This icon shows the strength of the remote controller signal. The icon will blink when an interference is recognized during flight. When there are no additional warnings in DJI GO 4, it means that the interference will not affect operation and overall flight experience.

9. HD Video Link Signal Strength

: This icon shows the strength of the HD video downlink connection between the aircraft and the remote controller. The icon will blink when an interference is recognized during flight. When there are no additional warnings in DJI GO 4, it means that the interference will not affect operation and overall flight experience.

10. Battery Settings

 **61%**: Shows the current battery level. Tap to view the battery information menu, set the various battery warning thresholds, and view the battery warning history.

11. Focus/Metering Button



Tap to switch between focus and metering mode. Tap to select object for focusing or metering. Auto Focus-Continuous will be triggered automatically according to the status of the aircraft and camera after enabling Auto Focus.

12. General Settings :

••• : Tap to enter the General Settings menu to set units of measurement, enable/disable livestream, and adjust flight route display settings.

13. Auto Exposure Lock

🔒 AE : Tap to lock the exposure value.

14. Gimbal Slider

•••••••••• : Displays the gimbal tilt angle.

15. Photo/Video Toggle



Tap to switch between photo and video recording modes.

16. Shoot/Record Button



Tap to start shooting photos or recording video.

17. Camera Settings



Tap to enter the Camera Settings menu.

Tap 📷 to set the camera's ISO, shutter, and auto exposure settings.

Tap 📷 to select photo shooting modes. The Mavic 2 supports Single Shot, Burst Shot, Interval Shot, and various Panorama modes.

Tap ⚙️ to enter the General Camera Settings menu.

18. Playback



Tap to enter Playback and preview photos and videos as soon as they are captured.

19. Flight Telemetry

D 30M : Distance between the aircraft and the Home Point.

H 10.0M : Height from the Home Point.

HS 10.0M/S : Aircraft horizontal speed.

VS 2.0M/S : Aircraft vertical speed.

20. Map

Tap to view the map.



21. Advanced Pilot Assistance Systems

 : Tap to enable/disable the APAS feature. The APAS feature is disabled if the Forward and Backward Vision Systems are disabled or unavailable.

22. Intelligent Flight Modes

 : Tap to select Intelligent Flight Modes.

23. Smart RTH

 : Tap to initiate Smart RTH and have the aircraft return to the last recorded Home Point.

24. Auto Takeoff/Landing

 : Tap to initiate auto takeoff or landing.

25. Back

 : Tap to return to the main menu.

 Please note the following when using Panorama mode:

- Use Panorama mode in a static scene. If the subject moves while shooting, the final panorama photo may look abnormal.
 - Use Panorama in a wide-open area and shoot at an altitude of 5 m or above.
 - Use Panorama in an area with many subjects and avoid shooting above water or snow.
 - Use Panorama when the aircraft can hover in place steadily. Do not use this mode in Attitude mode or when flying in high winds.
-

Editor

An intelligent video editor is built into the DJI GO 4 app. After recording several video clips and downloading them to your mobile device, go to Editor on the home screen. You can then select a template and a specified number of clips which are automatically combined to create a short film that can be shared immediately.

SkyPixel

View and share the photos and videos in the SkyPixel page.

Me

If you already have a DJI account, you will be able to participate in forum discussions, and share your creation with the community.



- Be sure to fully charge your mobile device fully before launching DJI GO 4.
 - Mobile cellular data is required when using DJI GO 4. Please contact your wireless carrier for data charges.
 - If you are using a phone as your mobile display device, DO NOT accept phone calls or use the texting features during flight.
 - Read all safety tips, warning messages, and disclaimers carefully. Be familiar with the related regulations in your area. You are solely responsible for being aware of all relevant regulations and flying in a way that is compliant.
 - a. Read and understand the warning messages before using the Auto-take off and Auto-landing features.
 - b. Read and understand the warning messages and disclaimer before setting the altitude beyond the default limit.
 - c. Read and understand the warning messages and disclaimer before switching between flight modes.
 - d. Read and understand the warning messages and disclaimer prompts near or in no-fly zones.
 - e. Read and understand the warning messages before using the Intelligent Flight Modes.
 - Land your aircraft immediately at a safe location if an alert shows on the app.
 - Review all warning messages on the checklist displayed in the app before each flight.
 - Use the in-app simulator to practice your flight skills if you have never operated the aircraft or if you do not have sufficient experience to operate the aircraft with confidence.
 - Beginner Mode is enabled by default when you launch the app for the first time. The aircraft's altitude and flight distance are restricted when flying in Beginner Mode. We recommend you fly in Beginner Mode to perfect your flight skills. Only disable Beginner Mode when you can operate the aircraft with confidence.
 - Cache the map data of the area where you intend to fly the aircraft by connecting to the internet before each flight.
 - The app is designed to assist your operation. Please use your sound discretion and DO NOT rely on the app to control your aircraft. Your use of the app is subject to DJI GO 4 Terms of Use and DJI Privacy Policy. Please read them carefully in the app.
-

Flight

This section describes safe flight practices and flight restrictions.

Flight

Once pre-flight preparation is complete, it is recommended to use the flight simulator in DJI GO 4 to hone your flight skills and practice flying safely. Ensure that all flights are carried out in an open area. Refer to the Remote Controller and DJI GO 4 sections for information about using the remote controller and the app to control the aircraft.

Flight Environment Requirements

1. Do not use the aircraft in severe weather conditions including wind speeds exceeding 10 m/s, snow, rain, and fog.
2. Fly in open areas. Tall structures and large metal structures may affect the accuracy of the onboard compass and GPS system.
3. Avoid obstacles, crowds, high voltage power lines, trees, and bodies of water.
4. Minimize interference by avoiding areas with high levels of electromagnetism such as locations near power lines, base stations, electrical substations, and broadcasting towers.
5. Aircraft and battery performance is subject to environmental factors such as air density and temperature. Be very careful when flying 19685 ft (6000 m) or more above sea level, since battery and aircraft performance may be reduced.
6. The Mavic 2 cannot use GPS within the polar areas. Use the Downward Vision System when flying in such locations.

Flight Limits and GEO Zones

Abide by all laws and regulations when flying your Mavic 2 Pro/Zoom. Flight limitations are applied by default to help users operate this product safely and legally. Flight limitations include altitude limits, distance limits, and GEO Zones.

Altitude limits, distance limits, and GEO Zones function concurrently to manage flight safety when operating in P-mode.

Flight Altitude and Distance Limits

The flight altitude and distance limits may be changed in DJI GO 4. The maximum flight altitude setting cannot exceed 1640 ft (500 m). Based on these settings, the aircraft will fly in a restricted cylinder, as shown below:

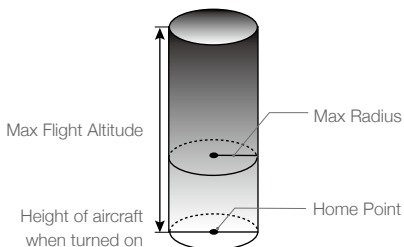

GPS Signal Strong  Blinking Green			
	Flight Limits	DJI GO 4 App	Aircraft Status Indicator
Max Altitude	Aircraft's altitude cannot exceed the specified value.	Warning: Height limit reached.	N/A
Max Distance	Flight distance must be within the max radius.	Warning: Distance limit reached.	N/A

GPS Signal Weak  Blinking Yellow			
	Flight Limits	DJI GO 4 App	Aircraft Status Indicator
Max Altitude	Height is restricted to 16 feet (5 meters) when the GPS signal is weak and Downward Vision System is activated. Height is restricted to 98 feet (30 meters) when the GPS signal is weak and Downward Vision System is inactivated.	Warning: Height limit reached.	N/A
Max Distance	No limit		

-  • If the aircraft reaches one of the limits, you can still control the aircraft, but you cannot fly it any farther.
- If the aircraft flies out of the max radius, it will fly back within range automatically when the GPS signal is strong.
- For safety reasons, please do not fly close to airports, highways, railway stations, railway lines, city centers, or other sensitive areas. Fly the aircraft only within your line of sight.

GEO Zones

All GEO Zones are listed on the DJI official website at <http://www.dji.com/flysafe>. GEO Zones are divided into different categories and include locations such as airports, flying fields where manned aircraft operate at low altitudes, borders between countries, and sensitive locations such as power plants.

Pre-Flight Checklist

1. Ensure the remote control device, mobile device, and Intelligent Flight Battery are fully charged.
2. Ensure the Intelligent Flight Battery and the propellers are mounted securely.
3. Ensure the aircraft arms and propellers are unfolded.
4. Ensure the gimbal and camera are functioning normally.
5. Ensure that there is nothing obstructing the motors and that they are functioning normally.
6. Ensure that DJI GO 4 is successfully connected to the aircraft.
7. Ensure that the camera lens and Vision System sensors are clean.
8. Use only genuine DJI parts or parts certified by DJI. Unauthorized parts or parts from non-DJI certified manufacturers may cause system malfunctions and compromise safety.

Auto Takeoff/Landing

Auto Takeoff

1. Launch DJI GO 4 and tap "GO FLY" to enter Camera View.
2. Complete all steps in the pre-flight checklist.
3. Tap .
4. If conditions are safe for takeoff, slide the slider to confirm. The aircraft will take off and hover 3.9 ft (1.2 m) above the ground.

 The Aircraft Status Indicator indicates whether the aircraft is using GPS and/or the Downward Vision System for flight control. Refer to the Aircraft LEDs and Status Indicator section for more information. It is recommended to wait until the GPS signal is strong before using auto-takeoff.

Auto-Landing

Only use auto-landing if the Aircraft Status Indicator is blinking green. Follow the steps below to use the auto landing feature:

1. Tap .
2. If conditions are safe to land, slide the slider to confirm. The aircraft will commence the auto landing procedure. Warnings will appear in DJI GO 4 if the aircraft detects that conditions are not suitable to land. Be sure to respond promptly.

 Auto-landing can be aborted immediately by tapping in DJI GO 4.

Starting/Stopping the Motors

Starting the Motors

A Combination Stick Command (CSC) is used to start the motors. Push both sticks to the inner or outer bottom corners to start the motors. Once the motors have started spinning, release both sticks simultaneously.

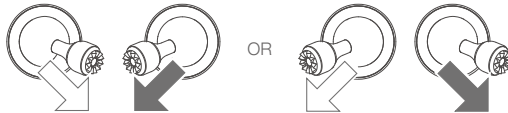

Stopping the Motors

There are two methods to stop the motors:

Method 1: When the aircraft has landed, push and hold the left stick down. The motors stop after three seconds.

Method 2: When the aircraft has landed, conduct the same CSC that was used to start the motors, as described above. The motors stop immediately. Release both sticks once the motors have stopped.

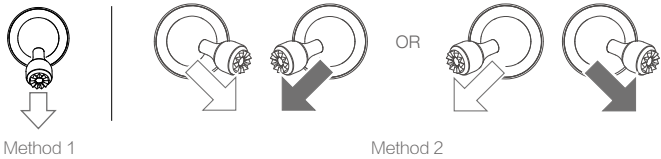

Stopping Motors Mid-Flight

Stopping the motors mid-flight will cause the aircraft to crash. The motors should only be stopped mid-flight in an emergency situation such as if a collision has occurred, a motor has stalled, the aircraft is rolling in the air, or the aircraft is out of control and is ascending/descending very quickly. To stop the motors mid-flight, use the same CSC that was used to start the motors.

Test Flight

Takeoff/Landing Procedures

1. Place the aircraft in an open, flat area with the Aircraft Status Indicator facing towards you.
2. Turn on the aircraft and the remote controller.
3. Launch DJI GO 4 and enter Camera View.
4. Wait until the Aircraft Status Indicator blinks green indicating that the Home Point has been recorded and it is now safe to fly.
5. Gently push the throttle stick to take off or use auto-takeoff.
6. Pull the throttle stick or use auto-landing to land the aircraft.
7. Turn off the aircraft and remote controller.

Video Suggestions and Tips

1. The pre-flight checklist is designed to help you fly safely and to ensure that you can shoot video during flight. Go through the full pre-flight checklist before each flight.
2. Select the desired gimbal operation mode in DJI GO 4.
3. Only shoot video when flying in P-mode or T-mode.
4. Always fly in good weather and avoid flying in rain or wind.
5. Choose the camera settings that best suit your needs. Settings include photo format and exposure compensation.
6. Perform flight tests to establish flight routes and to preview scenes.
7. Push the control sticks gently to keep the aircraft movement smooth and stable.

Appendix

Appendix

Specifications

Aircraft

Takeoff Weight	907 g (Mavic 2 Pro); 905 g (Mavic 2 Zoom)
Dimensions	Folded: 214×91×84 mm (length×width×height) Unfolded: 322×242×84 mm (length×width×height)
Diagonal Distance	354 mm
Max Ascent Speed	5 m/s (S-mode), 4 m/s (P-mode)
Max Descent Speed	3 m/s (S-mode), 3 m/s (P-mode)
Max Speed	72 km/h (S-mode) (near sea level, no wind)
Max Service Ceiling Above Sea Level	6000 m
Max Flight Time	31 minutes (at a consistent 25 kph) (no wind)
Max Hovering Time	29 minutes (no wind)
Overall Flight Time	25 minutes (In normal flight, 15% remaining battery level)
Max Flight Distance	18 km (at a consistent 50 kph) (no wind)
Max Wind Speed Resistance	29–38 kph
Max Tilt Angle	35° (S-mode, with remote controller), 25° (P-mode)
Max Angular Velocity	200°/s
Operating Temperature Range	-10°C - 40°C
GNSS	GPS+GLONASS
Hovering Accuracy Range	Vertical: ± 0.1 m (when vision positioning is active) ± 0.5 m (with GPS positioning) Horizontal: ± 0.3 m (when vision positioning is active) ± 1.5 m (with GPS positioning)
Operating Frequency	2.400 - 2.4835 GHz; 5.725 - 5.850 GHz
Transmission Power (EIRP)	2.4 GHz FCC: ≤26 dBm; CE: ≤20 dBm; SRRC: ≤20 dBm; MIC: ≤20 dBm 5.8 GHz FCC: ≤26 dBm; CE: ≤14 dBm; SRRC: ≤26 dBm
Internal Storage	8 GB
Gimbal	
Mechanical Range	Tilt: -135 to 45°, Pan: -100 to 100°, Roll: -45 to 45°
Controllable Range	Tilt: -90 to 30°, Pan: -75 to 75°
Stabilization	3-axis (tilt, roll, pan)
Max Control Speed (tilt)	120°/s
Angular Vibration Range	±0.01° (Mavic 2 Pro) ; ±0.005° (Mavic 2 Zoom)

Sensing System		
Sensing System	Omnidirectional Obstacle Sensing	
FOV	Forward: Horizontal: 40°, Vertical: 70°; Backward: Horizontal: 60°, Vertical: 77°; Downward: Front and Back: 100°, Left and Right: 83° Lateral: Horizontal: 80°, Vertical: 65°	
Obstacle Sensing Range	Forward: Precision Measurement Range: 0.5 - 20 m Detectable Range: 20 - 40 m Effective Sensing Speed: ≤ 14m/s Backward: Precision Measurement Range: 0.5 - 16 m Detectable Range: 16 - 32 m Effective Sensing Speed: ≤ 12m/s Upward: Precision Measurement Range: 0.1 - 8 m Downward: Precision Measurement Range: 0.5 - 11 m Detectable Range: 11 - 22 m Sides: Precision Measurement Range: 0.5 - 10 m Effective Sensing Speed: ≤ 8 m/s	
Operating Environment	Surface with clear pattern and adequate lighting (lux > 15) Detects diffuse reflective surfaces (>20%) (walls, trees, people, etc.)	
Velocity Range	≤31mph (50 kph) at 6.6 ft (2 m) above ground	
Altitude Range	0.1 - 11 m	
Operating Range	0.3 - 50 m	
Camera	Mavic 2 Pro	Mavic 2 Zoom
Sensor	1" CMOS Effective Pixels: 20 million	1/2.3" CMOS Effective Pixels: 12 million
Lens	FOV: about 77° 35 mm Format Equivalent: 28 mm Aperture: f/2.8–f/11 Shooting Range: 1 m to ∞	FOV: about 83° (24 mm); about 48° (48 mm) 35 mm Format Equivalent: 24-48 mm Aperture: f/2.8 (24 mm)–f/11 (48 mm) Shooting Range: 0.5 m to ∞
ISO Range	Video: 100-6400 Photo: 100-3200 (auto) 100-12800 (manual)	Video: 100-3200 Photo: 100-1600 (auto) 100-3200 (manual)
Shutter Speed	Electronic Shutter: 8–1/8000s	Electronic Shutter: 8–1/8000s
Still Image Size	5472×3648	4000×3000
Still Photography Modes	Single shot Burst shooting: 3/5 frames Auto Exposure Bracketing (AEB): 3/5 bracketed frames at 0.7 EV Bias Interval (JPEG): 2/3/5/7/10/15/20/30/60s RAW: 5/7/10/15/20/30/60s	Single shot Burst shooting: 3/5/7 frames Auto Exposure Bracketing (AEB): 3/5 bracketed frames at 0.7 EV Bias Interval (JPEG): 2/3/5/7/10/15/20/30/60s RAW: 5/7/10/15/20/30/60s
Video Resolution	4K: 3840×2160 24/25/30p 2.7K: 2688×1512 24/25/30/48/50/60p FHD: 1920×1080 24/25/30/48/50/60/120p	4K: 3840×2160 24/25/30p 2.7K: 2688×1512 24/25/30/48/50/60p FHD: 1920×1080 24/25/30/48/50/60/120p

Color Mode	Dlog-M (10-bit), support HDR video (HLG 10-bit)	D-Cinelike
Max Video Bitrate	100 Mbps	100 Mbps
Supported File System	FAT32: ≤ 32 GB exFAT: > 32 GB	FAT32: ≤ 32 GB exFAT: > 32 GB
Photo Format	JPEG / DNG (RAW)	JPEG / DNG (RAW)
Video Format	MP4 / MOV (MPEG-4 AVC/H.264, HEVC/H.265)	MP4 / MOV (MPEG-4 AVC/H.264, HEVC/H.265)
Supported SD Cards	Micro SD Supporting Micro SD with capacity up to 128 GB and R/W speed up to UHS-I Speed Grade 3	Micro SD Supporting Micro SD with capacity up to 128 GB and R/W speed up to UHS-I Speed Grade 3
Operating Temperature Range	-10°C to 40°C	-10°C to 40°C
HDR	Enhanced HDR, 14 EV	HDR, 13 EV
Hyperlight	8dB SNR	8dB SNR
Panorama	Pano (3×1): 4000×6000 (40°×80°) W (3×3): 8000×6000 (113°×80°) 180° (3×7): 8192×2840 (240°×76°) Sphere (3×8+1): 8192×4096 (360°×126°, 360°×180°)	Pano (3×1): 4000×6000 (41°×93°) W (3×3): 8000×6000 (117°×93°) 180° (3×7): 8192×2840 (249°×87°) Sphere): (3×8+1) 8192×4096 (360°×126°, 360°×180°) Super Resolution): 8000×6000 (24 mm equivalent FOV)

Remote Controller

Operating Frequency	2.400 - 2.4835 GHz; 5.725 - 5.850 GHz
Max Transmission Distance	FCC: 8000 m; CE: 5000 m; SRRC: 5000 m; MIC: 5000 m (unobstructed, free of interference)
Operating Temperature Range	0°C - 40°C
Battery	3950 mAh
Transmission Power (EIRP)	2.400 - 2.4835 GHz FCC: ≤26 dBm; CE: ≤20 dBm; SRRC: ≤20 dBm; MIC: ≤20 dBm 5.725 - 5.850 GHz FCC: ≤26 dBm; CE: ≤14 dBm; SRRC: ≤26 dBm
Operating Current/Voltage	1800 mA @ 3.83 V
Supported Mobile Device Size	Max length: 160 mm; max thickness: 6.5 – 8.5 mm
Supported USB Port Types	Lightning, Micro USB (Type-B), USB-C
Charger	
Input	100-240 V, 50/60 Hz, 1.8 A
Output	Main: 17.6 V = 3.41 A or 17.0 V = 3.53 A USB: 5 V = 2 A
Voltage	17.6±0.1 V or 17.0 V±0.1 V

Rated Power	60 W
Intelligent Flight Battery	
Capacity	3850 mAh
Voltage	15.4 V
Max Charging Voltage	17.6 V
Battery Type	LiPo 4S
Energy	59.29 Wh
Net Weight	297 g
Charging Temperature Range	5°C - 40°C
Max Charging Power	80 W
APP	
Video Transmission System	OcuSync 2.0
Name	DJI GO 4
Live View Quality	Remote Controller: 720p@30fps / 1080p@30fps DJI Goggles: 720p@30fps / 1080p@30fps DJI Goggles RE: 720p@30fps / 1080p@30fps
Latency (depending on environmental conditions and mobile device)	120 - 130 ms
Required Operating System	iOS 9.0 or later Android 4.4 or later

Calibrating the Compass

It is recommended that the compass is calibrated in any of the following situations when flying outdoors:

1. Flying at a location farther than 31 miles (50 km) away from the location the drone was last flown.
2. The aircraft has not been flown for more than 30 days.
3. A compass interference warning appears in DJI GO 4 and/or the Aircraft Status Indicators blink alternating red and yellow.



- DO NOT calibrate the compass in locations where magnetic interference may occur, such as close to magnetite deposits or large metallic structures such as parking structures, steel reinforced basements, bridges, cars, or scaffolding.
- DO NOT carry objects (such as cell phones) that contain ferromagnetic materials near the aircraft during calibration.
- It is not necessary to calibrate the compass when flying indoors.

Calibration Procedure

Choose an open area to carry out the following procedure.

1. Tap the System Status Bar in DJI GO 4, select “Calibrate”, and follow the on-screen instructions.
2. Hold the aircraft horizontally and rotate it 360 degrees. The Aircraft Status Indicator will turn solid green.
3. Hold the aircraft vertically, with its nose pointing downward, and rotate it 360 degrees around a vertical axis.
4. If the Aircraft Status Indicator blinks red, the calibration has failed. Change your location and try the calibration procedure again.

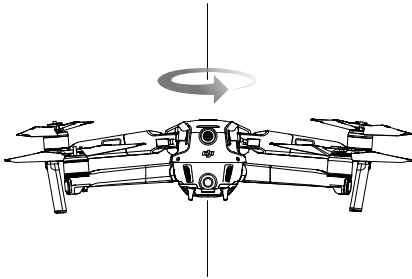

Horizontal Calibration



Vertical Calibration



- The aircraft can take off immediately once calibration is complete. If you wait more than three minutes to take off after calibration, you may need to calibrate again. It is possible that another compass interference warning will appear while the aircraft is on the ground. This indicates that the current location is not suitable for flying the aircraft, due to the level of magnetic interference.

Firmware Updates

Use DJI GO 4 or DJI Assistant 2 to update the aircraft firmware.

Using DJI GO 4

When you connect the aircraft or remote controller to DJI GO 4, you will be notified if a new firmware update is available. To start updating, connect your mobile device to the internet and follow the on-screen instructions. Note that you cannot update the firmware if the remote controller is not linked to the aircraft.

Using DJI Assistant 2

The USB-C port is used when connecting the aircraft to a computer to update firmware. Follow the instructions below to update the firmware through DJI Assistant 2:

1. With the aircraft powered off, connect the aircraft to a computer via the Micro USB port using a Micro USB cable.
2. Power on the aircraft.
3. Launch DJI Assistant 2 and log in with your DJI account.
4. Select "Mavic 2" and click on Firmware Updates on the left panel.
5. Select the firmware version that you wish to update to.
6. Wait for the firmware to download. The firmware update will start automatically.
7. Reboot the aircraft after the firmware update is complete.



- Ensure the aircraft is connected to the computer before powering on.
- The firmware update will take around 15 minutes. It is normal that the gimbal goes limp, aircraft status indicators blink, and the aircraft reboots. Please wait patiently until the update is complete.
- Ensure the computer has access to the Internet.
- Before performing an update ensure the Intelligent Flight Battery has at least 50% power and the remote controller has at least 30% power.
- Do not disconnect the aircraft from the computer during an update.
- For safety, always update the firmware to the latest version when an upgrade notification is shown in DJI GO 4.
- Firmware upgrade notifications will prompt you to proceed with an update immediately or to update the firmware within three days. If you choose to ignore the current firmware update, you are required to accept the prompted disclaimer. You further understand and agree that the data includes but is not limited to user selection records and may be uploaded to and maintained on a DJI designated server.
- The remote control device may become unlinked from the aircraft after updating. Re-link the remote control device and aircraft.
- Be sure to check all connections and remove the propellers from the motors before performing the firmware update. DO NOT disconnect the aircraft or remote controller from the computer or internet while updating the firmware.

Remote Controller LCD Screen Menu Information

Remote Controller Status	
BAT xx PCT	Remote Controller battery level.
SHUTDOWN_	Remote controller is powering off.
CHARGING_	Remote controller is charging.
USB PLUGGED	Mavic 2 has been connected to a computer.
FC U-DISK	Flight Controller is reading data.
UPGRADING	Upgrading.
BINDING	Aircraft is binding with the remote controller.
Before Flight	
CONNECTING_	The remote controller is connecting to the aircraft.
SYS INITING	System is initiating.
READY TO GO	Ready to take off.
Flight Mode	
BEGINNER	In Beginner Mode.
GPS MODE	In P-GPS Mode.
OPTI MODE	In P-OPTI Mode.
ATTI MODE	In P-ATTI Mode.
SPORT MODE	In Sport Mode.
Flight Status	
TAKING OFF	Taking off.
LANDING	Landing.
GOING HOME	Returning to Home.

NAV GOHOME	Returning to home.
NAV LANDING	Landing.
MAX ALT.	Aircraft has reached maximum altitude.
MAX RADIUS	Aircraft has reached maximum radius.
OBSTACLE	Obstacle detected.
NO FLY ZONE	Aircraft is in a No Fly zone.
Intelligent Flight Mode Status	
TRIPOD	In Tripod Mode.
ACTIVETRACK	Using ActiveTrack.
TAP FLY	Using TapFly.
COURSE LOCK	In Course Lock Mode
HOME LOCK	In Home Lock Mode
POI MODE	In Point of Interest Mode
WAY POINT	In Waypoints Mode.
FOLLOW ME	In Follow Me Mode.
TERRAIN	In Terrain Follow Mode.
System Warning and Error Information	
SYS WARNING+CHECK APP	System Warning. See DJI GO 4 app for more information.
UNACTIVATED+CHECK APP	Aircraft not Activated. See DJI GO 4 app for more information.
MAG INTERF+CHECK APP	Compass Error. See DJI GO 4 app for more information.
BATTERY ERR+CHECK APP	Battery Error. See DJI GO 4 app for more information.
SD ERR+CHECK APP	Micro SD Card Error. See DJI GO 4 app for more information.
CALIBRATING	IMU Calibrating/Did not restart aircraft after calibration is complete.
STICK ERR+RE-CTR STCK	Control stick is not centered. Re-center it.
WHEEL ERR+RE-CTR WHEL	Left Dial on the remote controller is not centered. Re-center it.
STICK ERR	Control stick error. Calibrate the control sticks in the DJI GO 4 app.
MECH ERR	Remote Controller Error. Calibrate the remote controller in the DJI GO 4 app. If this problem persists, contact DJI support.
STICK EMI3+AUTO RTH	Control Sticks are experiencing severe electromagnetic interference and cannot function. The aircraft will return to home and land immediately.
STICK EMI2+MANUAL RTH	Control Sticks are experiencing electromagnetic interference and may not function. Use Smart RTH and land the aircraft as soon as possible.
STICK EMI1	Control Sticks are experiencing slight electromagnetic interference, fly the aircraft to another location.
SD FULL	Micro SD Card is full.
NO PROP	No propellers attached.
BAT TEMP HI	Intelligent Flight Battery is too hot.
BATTERY ERR	Intelligent Flight Battery error.
BAT TEMP LO	Intelligent Flight Battery is too cold.
LOW BATTERY	Intelligent Flight Battery low battery.
RC LOW BAT	Remote Controller low battery.
NO RC SIGNAL	Remote Controller signal lost.
RC TEMP HI	Remote Controller too hot.
NO RTH	Aircraft cannot Return to Home.

After-Sales Information

Visit <https://www.dji.com/support> to learn more about after-sales service policies, repair services and support.

DJI Support
<http://www.dji.com/support>

This content is subject to change.

Download the latest version from
<http://www.dji.com/mavic-2>



If you have any questions about this document, please contact DJI
by sending a message to **DocSupport@dji.com**.

MAVIC is a trademark of DJI.
Copyright © 2018 DJI All Rights Reserved.